

# Smartgen®

## HGM6520 Genset Synchronization Unit

### USER MANUAL

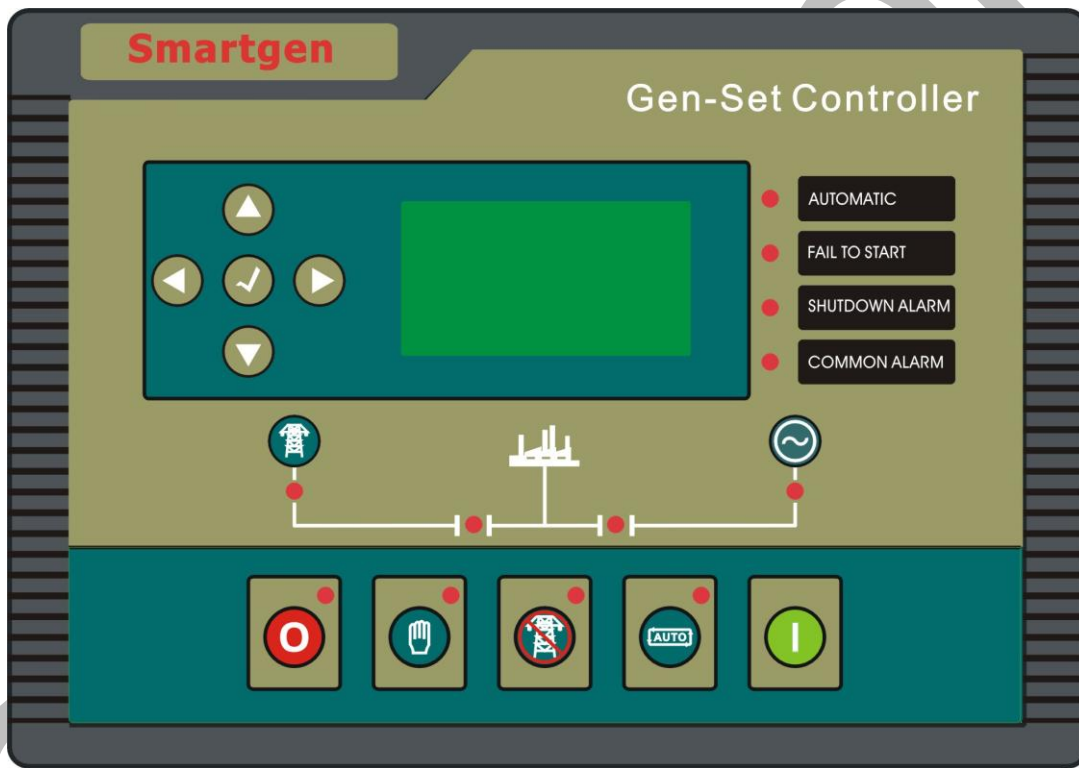

Smartgen Technology



众智电子 Chinese trademark

**Smartgen**<sup>®</sup> English trademark

**Smartgen** — make your generator *smart*

**Smartgen Technology Co., Ltd**

**No. 28 Jinsuo Road**

**Zhengzhou**

**Henan Province**

**P. R. China**

**Tel: +86-371-67988888/67981888**

+86-371-67991553/67992951/67992952

+86-371-67981000(overseas)

**Fax: 0086-371-67992952/67981000**

Web: <http://www.smartgen.com.cn>

<http://www.smartgen.cn>

Email: [sales@smartgen.com.cn](mailto:sales@smartgen.com.cn)

All rights reserved. No part of this publication may be reproduced in any material form (including photocopying or storing in any medium by electronic means or other) without the written permission of the copyright holder.

Smartgen Technology reserves the right to change the contents of this document without prior notice.

#### **Software Version**

Date	Version	Note
2011-06-15	1.0	Original release.

---

**TABLE OF CONTENTS**

1	SUMMARY .....	6
2	PERFORMANCE AND CHARACTERISTICS .....	6
3	SPECIFICATION .....	7
4	KEYS DESCRIPTION .....	8
5	OPERATION .....	10
5.1	AUTOMATIC START/STOP SYNCHRONIZATION OPERATION .....	10
5.1.1	Automatic Mains Failure (AMF) .....	10
5.1.2	Remote Start Island Mode .....	11
5.1.3	Remote Start Load Mode .....	11
5.2	MANUAL START/STOP SYNCHRONIZATION OPERATION .....	12
6	PROTECTION .....	13
6.1	WARNINGS .....	13
6.2	SHUTDOWN ALARM .....	16
6.3	ELECTRICAL TRIPS SHUTDOWN .....	17
7	PANEL CONFIGURATION .....	19
7.1	LCD DISPLAY .....	19
7.1.1	Status Display .....	19
7.1.2	Engine Display .....	19
7.1.3	GENERATOR DISPLAY .....	20
7.1.4	MAINS DISPLAY .....	21
7.1.5	SYNCHRONIZATION DISPLAY .....	22

---

7.1.6	ALARMS DISPLAY .....	22
7.1.7	EVENT LOG .....	22
7.1.8	ABOUT .....	22
7.2	PARAMETERS CONFIGURATION .....	23
7.3	DATE/TIME CONFIGURATION .....	28
7.4	DATA DISPLAY .....	28
7.4.1	Basic Display .....	28
7.4.2	ECU Display .....	29
8	INPUT AND OUTPUT PORTS DEFINITION .....	29
8.1	CONFIGURABLE INPUT 1-9 .....	29
8.2	CONFIGURABLE OUTPUT 1-5 .....	31
9	EVENT LOG .....	36
10	REAR PANEL .....	36
11	ECU INTERFACE .....	39
12	COMMISSIONING PROCEDURE .....	39
12.1	STEP 1- SINGLE UNIT COMMISSIONING .....	39
12.2	STEP 2- MANUAL SYNCHRONIZATION (NO-LOAD) .....	40
12.3	STEP 3- MANUAL SYNCHRONIZATION (ON-LOAD) .....	40
13	MAINS SYNCHRONIZATION MODE .....	41
13.1	GENSET CONTROL MODE .....	41
13.2	MAINS CONTROL MODE .....	42
13.1	LOAD TAKEOVER MODE .....	43

13.1 AMF MODE.....	44
13.1 ISLAND MODE .....	45
14 FAULT FINDING .....	46
15 TYPICAL APPLICATION.....	46
16 COMMUNICATION INTERFACE.....	47
17 CASE DIMENSIONS AND PANEL CUTOUT .....	47

SmartGen

## 1 SUMMARY

**HGM6520** controller is applicable for manual/auto synchronization system of generator and mains, which can achieve automatic start/stop, data measurement, alarm protection and “four remote” (remote controlling, remote measuring, remote communication and remote adjustment). It adopts LCD display and optional Chinese–English interface with easy operation and reliable operation. The controller owns GOV (Engine Speed Governor) and AVR (Automatic Voltage Regulator) functions. Multiple working modes can be selected, such as genset fixed active power, reactive power/power factor output, mains peak shaving and uninterruptedly restore to mains supply.

**HGM6520** controller can accurately monitor various running status. When genset running is abnormal, it will disconnect bus bar and stop the genset. At the same time LCD displays the alarm information.

**HGM6520** controller based on 32-bit MPU design has SAE J1939 interface which can communicate with types of ECU (Engine Control Unit) with J1939 interface. Multiple parameters, like the engine speed, water temperature, oil temperature and oil pressure can be read directly via J1939 interface and displayed in LCD. Users do not need to install a sensor. Complex connections are reduced but accurate accuracy is ensured.

## 2 PERFORMANCE AND CHARACTERISTICS

- 32-bit MPU as the core, large LCD with back-light, optional English-Chinese display, push-button operation;
- Multiple running states under Auto mode: AMF (Automatic Mains Failure), Island Mode, Fixed Power, Peak Shaving Mode and Load Takeover Mode;
- Scheduling start and stop weekly/monthly. Commissioning with synchronization or without load can be chosen;
- Through SAE J1939 interface, can directly monitor ECU;
- RMS measuring, suitable for various occasions where electricity quantity is distorted;
- Accurate real-time measuring and display of electrical parameter, water temperature, oil pressure, fuel level and so on;
- Perfect mains protection: over/under frequency, over/under voltage, ROCOF and vector shift;

- Control and protection function: automatic start/stop/synchronization, synchronous detection, load sharing and alarm protection;
- **Maintenance due** warning/shutdown alarm;
- Parameter setting: users are approved to adjust parameters. Meanwhile, the setting will be saved into the internal Flash memory and never lost even power off;
- For the engines without J1939, temperature, pressure and fuel level sensors also can be installed and used. Sensor curve also can be user defined;
- Contents in LCD can be defined when programmable input is active. Optional Chinese and English interface can input max. 10 Chinese characters or 20 English letters;
- Can configure digital input as *close to activate* or *open to activate*. Can configure digital output as *normally open* or *normally closed*;
- Logic output can be defined as continuous output or pulse output;
- With real-time calendar, clock and hour counter;
- Can save 99 sets of event logs in cycle which can be backtracked on the spot;
- Multi-level password protection to avoid incorrect operations by non-professionals;
- Parameters can be adjusted from front panel or configured via PC;
- Power supply range: (8-35) VDC, adapt to different starting battery voltage;
- RS485/232C communication interface uses MODBUS-RTU communication protocol to realize “four remote” of the controller;
- Modular design, anti-flame ABS shell, plug-in terminals, embedded installation with compact structure and convenient mounting;



### 3 SPECIFICATION

Items	Contents
Working Voltage	DC8. 0V to 35. 0V, continuous
Power Consumption	<3W (Standby mode: ≤2W)
Alternator Voltage Input:	
3 Phase 4 Wire	15V AC - 360 V AC (ph-N)
3 Phase 3 Wire	30V AC - 600 V AC (ph-ph)
Single Phase 2 Wire	15V AC - 360 V AC (ph-N)
2 Phase 3 Wire	15V AC - 360 V AC (ph-N)
True RMS Accuracy	1%
Alternator Frequency.	50/60Hz
Speed Sensor Voltage	1. 0 V to 24 V (RMS)
Speed Sensor Frequency	Maximum 10,000 Hz









HGM6520 Automatic Control Module

Items	Contents
Start Relay Output	16 Amp DC28V power supply
Fuel Relay Output	16 Amp DC28V power supply
Programmable Output 1	Relay 16 Amp DC28V power supply
Programmable Output 2	Relay 16 Amp DC28V power supply
Programmable Output 3	Relay 16 Amp DC28V power supply
Programmable Output 4	Relay 16 Amp 250VAC passive output
Programmable Output 5	Relay 16 Amp 250VAC passive output
Case Dimensions	260mm x 182mm x 57mm
Panel Cutout	214mm x 160mm
CT Secondary Current	Rated 5A
Working Conditions	Temperature: (-25~+70)°C Humidity: (20~93)% without condensation
Storage Condition	Temperature:(-30~+80)°C
Protection Level	IP55: when waterproof rubber gasket added between controller and its panel IP42: when waterproof rubber gasket NOT added between controller and its panel
Insulation Intensity	Object: among input/output/power supply Quote standard: IEC688-1992 Test method: AC1.5kV/1min 3mA leakage current
Net Weight	0.90kg

#### 4 KEYS DESCRIPTION

	Stop/Reset	Pressing the key to stop the running genset; When an alarm occurs, pressing the key will reset alarm; In stop mode, pressing the key over 3 seconds will test all the panel indicators;(lamp test) During stopping, pressing the key again can shut down the genset immediately.
	Start	In manual mode and manual test mode, pressing the key will start genset.( ONLY in Manual mode)
	Manual Mode	Manual mode is activated by pressing this key.



	Test	Manual test mode is activated by pressing this key.
	Auto Mode	Automatic mode is activated by pressing this key.
	Close/Open Genset	Under manual mode, active when generator in normal running: 1. Stand-Alone Mode: when mains not closed, pressing the key can closed/open genset. 2. Synchronization Mode: a. When mains closed and genset open, pressing the key can synchronize genset with mains and close genset. b. When mains and genset both closed, pressing the key can transfer load to mains and open genset.
	Close/Open Mains	Under manual mode, active when mains normal: 1. Stand-Alone Mode: when genset not closed, pressing the key can closed/open mains. 2. Synchronization Mode: a. When genset closed and mains open, pressing the key can synchronize mains with genset and close mains. b. When mains and genset both closed, pressing the key can transfer load to genset and open mains.
	Up	Scroll screen Up; In parameter setting, press this key to increase value.
	Down	Scroll screen Down; In parameter setting, press this key to decrease value.
	Left	Scroll screen left; In parameter setting, press this key to shift cursor to left.
	Right	Scroll screen right; In parameter setting, press this key to shift cursor to right.
	Confirm	In parameter setting, pressing this key can confirm setting.

## 5 OPERATION

### 5.1 Automatic Start/Stop Synchronization Operation

Auto mode is activated by pressing  key; an LED indicator beside the button will illuminate to confirm this operation.

#### 5.1.1 AUTOMATIC MAINS FAILURE (AMF)

##### Starting Sequence,

1. When mains abnormal, unit enters into “Start Delay”;
2. “Start Delay” countdown is displayed in LCD;
3. When “start delay” ends, preheat relay outputs (if fitted), and LCD shows “Preheat Delay XX s”;
4. When “Preheat Delay” ends, the fuel relay outputs 1s(or via a start signal from ECU), then starter relay outputs; If the genset fails to start within “Start Timer”, the fuel relay and starter relay stop outputting and enter into “Crank Rest Time” to wait for next cranking;

**NOTE:** If the controller is configured as CANBUS active, then engine ECU will receive the start signal from CANBUS.

5. If failed to start within start attempts, the first row of LCD display is black and “Fail to Start” alarm is displayed in LCD;
6. If crank disconnect any time of the start attempts, it will enter into “Safety on Timer”. During this period, such alarms like low oil pressure, high water temperature, low speed and charge failure, are inactive. After the “Safety on Delay” ends, enter into Start Idle Delay” (if configured);

**NOTE:** If the controller is configured as CANBUS active, engine speed can be read from ECU directly.

7. During the period of “Start Idle Delay”, under speed/frequency/voltage alarms are inactive. After the “Start Idle Delay” is over, enter into “Warm up Delay” (if configured);
8. When “Warm up Delay” is over, if genset normal, indicator will illuminate. When voltage and frequency of the alternator reach the load demand, open mains and close genset, genset takes load and power indicator illuminates to enter into normal running; when voltage or frequency is abnormal, controller will alarm to shutdown. (details of alarm is displayed in LCD)

##### Auto Stopping Sequence,

1. When mains normal, GOV and AVR will be adjusted by controller in order to make genset synchronous with mains. When synchronization condition is met, closing signal is initiated to synchronization genset with mains and "Stop Delay" begins. Genset mode or mains mode output can be selected;
2. When "Stop delay" is over, controller will gradually transfer load to mains, send open signal, and then "Cooling Delay" begins. When the "Cooling Delay" is over, unit enters into "Stop Idle Delay";
3. During "Stop Idle Delay" (if configured), idle relay is energized to output. If the controller is configured as CANBUS active, CANBUS can execute stop function;
4. During "ETS Delay", the ETS relay is energized to output. The fuel relay output is disconnected;
5. During "genset at rest timer", automatically judge if unit is steady or not;
6. When genset at rest, enter into standby state; if the unit fails to stop, the controller will alarm. ("Fail to Stop" is displayed in LCD)

#### **5.1.2 REMOTE START ISLAND MODE**



- 1) When remote start input is active, enter into "Start Delay" ;
- 2) As for starting sequence, please refer to 2-7 of **Automatic Mains Failure (AMF)** ;
- 3) When hi-speed "Warm Up Delay" ends, indicator will illuminate when genset normal; GOV and AVR are adjusted to make genset synchronous with mains. When synchronization condition is met, controller will send closing signal to synchronization genset with mains. After transferring load to genset, open mains;
- 4) When remote start input is inactive, enter into "Stop Delay";
- 5) When "Stop Delay" is over, genset turns to synchronization with mains. Controller will transfer load to mains and then open genset;
- 6) Generator stops normally.

#### **5.1.3 REMOTE START LOAD MODE**

- 1) When remote start input is active, enter into "Start Delay" ;
- 2) As for starting sequence, please refer to 2-7 of **Automatic Mains Failure (AMF)**;
- 3) When "Warm Up Delay" ends, indicator will illuminate if genset normal; GOV and AVR are adjusted to make genset synchronous with mains. When synchronization condition is met, controller will send closing signal to synchronization genset with mains. Three modes can be selected as the following (PC software configuration):
  - a) **Genset Mode:** Genset maintains constant active power, inactive power/power factor output;

- b) **Mains Mode:** mains load is limited under default and the extra load is shared by Genset(peak shaving mode)
- c) **Load Receiving:** when genset has totally received mains load, open mains.
- 4) when remote start input is inactive, enter into “Stop Delay” ;
- 5) When “Stop Delay” ends, close genset, and then unit stops normally;



## 5.2 Manual Start/Stop Synchronization Operation

1. Manual mode is activated by pressing  key and an LED indicator beside the key will illuminate to confirm this operation. Press  key to start the genset;
2. Preheat relay outputs (if configured), LCD screen shows “Preheat Delay XX s”;
3. When preheat delay ends, fuel relay outputs 1s (or via a start signal from ECU), and then start relay outputs; if the failed to start within “start times”, both the fuel relay and start relay stop outputting and enter into “Crank Rest Time” to wait for the next cranking;



**NOTE:** If the controller is configured as CANBUS active, engine ECU will receive a start signal from CANBUS.

4. If failed to start within start attempts, the first row of LCD display is black and “Fail to Start” alarm is displayed in LCD;
5. If crank disconnect any time of the start attempts, it will enter into “Safety on Timer”. During this period, such alarms like low oil pressure, high water temperature, low speed and charge failure, are inactive. After the “Safety on Delay” ends, enter into Start Idle Delay” (if configured);

**NOTE:** If the controller is configured as CANBUS active, engine speed can be read from ECU directly.

6. During the period of “Start Idle Delay”, under speed/frequency/voltage alarms are inactive. After the “Start Idle Delay” is over, enter into “Warm up Delay” (if configured);
7. When “Warm up Delay” is over, genset waits for taking load;
8. Press  key (close/open genset), when “Warm up Delay” is over, if genset normal the indicator will illuminate. When voltage and frequency of the alternator reach the load demand, closing relay of genset outputs, genset is taking load and power supply indicator illuminates to enter into normal running; Pressing  key during synchronous running can adjust GOV and AVR to make genset

synchronous with mains. When synchronization condition is met, closing signal is initiated to synchronization genset with mains. Genset mode or mains mode output can be selected;

9. Pressing  key during running can control mains closed/open. Under synchronous running ( mains open ), press this key, genset turns to synchronize with mains and close mains. When mains closed, press the key again to transfer mains to genset and open mains;
10. Press  key, open genset to shut down the unit.

## 6 PROTECTION

When an alarm occurs, the common alarm indicator (if configured) will illuminate and the alarm information will be displayed in LCD.

### 6.1 Warnings

Warnings are non-critical alarm conditions and do not affect the operation of the generator system. They serve to draw the operators' attention to an undesirable condition. Warning alarms is shown as the below:

No	Items	Range	Description
1	Genset Current Over	Always active	When controller detects a generator output current in excess of the pre-set trip a warning alarm initiates. Warning is displayed in LCD.
2	Fail To Stop	After stop delay timer is over	When genset stop delay timer is over, if genset output is power on and oil pressure is not 0, warning alarm signal will be send and details is displayed in LCD.
3	Low Fuel Level	Always active	When controller detects fuel level in excess of the pre-set value a warning alarm initiates. Warning is displayed in LCD.
4	Charge Failure	From start idle to stop idle	When controller detects charge voltage in excess of the pre-set value a warning alarm initiates. Warning is displayed in LCD.
5	Loss Of Speed Signal	From crank disconnect to stop idle	When controller detected the speed of genset is 0, warning alarm signal will be sent, and warning is displayed in LCD.

HGM6520 Automatic Control Module

No	Items	Range	Description
6	Battery Voltage Low	Always active	When controller detects start battery voltage in excess of the pre-set value a warning alarm initiates. Warning is displayed in LCD.
7	Battery Voltage Over	Always active	When controller detects start battery voltage above the pre-set value a warning alarm initiates. Warning is displayed in LCD.
8	Open Failure Genset	Always active	When break-off delay timer is over, and controller couldn't detect signal of break off, then warning alarm signal will be sent, and warning is displayed in LCD.
9	Auxiliary Input 1-9	User defined	When controller detected auxiliary input 1-9 warning input, warning alarm signal will be sent, and warning is displayed in LCD.
10	Maintenance Due	Always active	When engine accumulated run time or days exceeds preset maintenance time or days, warning alarm signal will be sent and displayed in LCD. *1
11	Synchronization Failure	Synchrony active	When controller can't detect synchrony signal within setting time, warning alarm signal will be sent, and warning is displayed in LCD.
12	Genset Phase-Sequence Error	Genset active	When controller detected phase sequence of genset is incorrect (should be L1 L2 L3), warning alarm signal will be sent, and warning is displayed in LCD.
13	Mains Phase-Sequence Error	Mains active	When controller detected phase sequence of mains is incorrect (should be L1 L2 L3), warning alarm signal will be sent, and warning is displayed in LCD.
14	ECU Warning	Always active	If the module receives an "error" message from ECU, a warning alarm is generated, and "Can ECU error" is shown in LCD.
15	Load Current Unbalance	Genset closed	When controller detected unbalance value is above pre-set value, warning alarm signal will be sent, and warning is displayed in LCD.

HGM6520 Automatic Control Module

No	Items	Range	Description
16	High Temp Warn	From start idle to stop idle	When controller detected engine's temperature is over than pre-set, warning alarm signal will be sent, and warning is displayed in LCD.
17	Low Temp Warn	Always active	When controller detected engine's temperature is less than pre-set, warning alarm signal will be sent, and warning is displayed in LCD.
18	Low Oil Pressure	From start idle to stop idle	When controller detected engine's oil pressure is less than pre-set, warning alarm signal will be sent, and warning is displayed in LCD.
19	Over Speed	Always active	When controller detected engine's speed is above pre-set, warning alarm signal will be sent, and warning is displayed in LCD.
20	Under Speed	From wait for loading to cooling timer	When controller detected engine's speed is less than pre-set, warning alarm signal will be sent, and warning is displayed in LCD.
21	Genset Over Frequency	Always active	When controller detected engines voltage frequency is above pre-set, warning alarm signal will be sent, and warning is displayed in LCD.
22	Genset Under Frequency	From wait for loading to cooling timer	When controller detected engines voltage frequency is less than pre-set, warning alarm signal will be sent, and warning is displayed in LCD.
23	Genset Over Voltage	Always active	When controller detected engines voltage is over than pre-set, warning alarm signal will be sent, and warning is displayed in LCD.
24	Genset Under Voltage	From wait for loading to cooling timer	When controller detected engines voltage is less than pre-set, warning alarm signal will be sent, and warning is displayed in LCD.
25	Loss of Excitation	Always active	When controller detected engines negative reactive power is over than pre-set, warning alarm signal will be sent, and warning is displayed in LCD.
26	Mains Closed Error	Always active	When mains closed output, closed input cannot be detected.

No	Items	Range	Description
27	Mains Open Error	Always active	When mains open output, disconnection input cannot be detected.

▲ When maintenance time up, configure an input port as “reset maintenance alarm”, and then it can be removed by an active grounding pulse signal.

## 6.2 Shutdown Alarm

Shutdown alarm will not disappear until manual reset to remove. As soon as “Alarm shutdown” is generated, genset will immediately shutdown.

No	Items	Range	Description
1	Emergency Stop	Always active	When controller detects emergency stop alarm signal, alarm signal is sent, and alarm is displayed in LCD.
2	High Temperature	From the start idle to stop idle	When controller detects engine's water temperature is over pre-set, alarm signal is sent, and alarm is displayed in LCD.
3	Low Oil Pressure	From the start idle to stop idle	When controller detects engine's oil pressure is under pre-set, alarm signal is sent, and alarm is displayed in LCD.
4	Genset Over Speed	Always active	When controller detects engine's speed is over pre-set, alarm signal is sent, and alarm is displayed in LCD.
5	Genset Under Speed	From genset wait for loading to cooling timer	When controller detects engine's speed is under pre-shutdown setting, alarm signal is sent, and alarm is displayed in LCD.
6	Loss Of Speed Signal	From genset start successfully to stop idle	When controller detects engine's speed is 0, alarm signal is sent, and alarm is displayed in LCD.
7	Genset Over Frequency	Always active	When controller detects voltage frequency is over pre-set, alarm signal is sent, and alarm is displayed in LCD.
8	Genset Under Frequency	From genset wait for loading to cooling timer	When controller detects voltage frequency is under pre-set, alarm signal is sent, and alarm is displayed in LCD.
9	Genset Over Voltage	Always active	When controller detects voltage is over pre-set, alarm signal is sent, and alarm is displayed in LCD.



No	Items	Range	Description
10	Genset Voltage Under	From genset wait for loading to cooling timer	When controller detects voltage is under pre-set, alarm signal is sent, and alarm is displayed in LCD.
11	Genset Current Over	Always active	When controller detects current is over pre-set, alarm signal is sent, and alarm is displayed in LCD.
12	Fail To Start	Failed within start attempts	Genset fails to start within pre-set attempts, alarm signal is sent, and shutdown alarm is displayed in LCD.
13	Oil Pressure Sensor Open	Always active	When controller detects oil pressure sensor is open, alarm signal is sent, and alarm detail is displayed in LCD.
14	Auxiliary Input 1-9	Users defined	When controller detects alarm from input ports 1-9, alarm signal is sent, and alarm is displayed in LCD.
15	CANBUS Error	When CANBUS configured as active and genset is fired.	When controller can't detect ECU, alarm signal is sent, and alarm is displayed in LCD. This fault maybe caused by Can Bus open circuit, short circuit or error connection.
16	Load Current Unbalance	when genset closed	When controller detects load current imbalance value is over pre-set, alarm signal is sent, and alarm is displayed in LCD.
17	ECU Alarm	When CANBUS configured as active and engine is fired.	When receives a shutdown alarm from engine's ECU via CANBUS alarm signal is sent by controller, and alarm is displayed in LCD.
18	Genset Closed Error	Always active	When genset closed output, closed input cannot be detected.
19	Genset Open Error	Always active	When genset open output, disconnection input cannot be detected.

### 6.3 Electrical Trips Shutdown

Electrical trips are latching and stop the Generator but in a controlled manner. On initiation of the electrical trip condition the module will de-energies the '**Close Generator**' Output to remove the load from the generator.

No	Items	Range	Description
1	Genset Current Over	Always active	When controller detects current is over pre-set, alarm signal is sent, and alarm is displayed in LCD. *1

HGM6520 Automatic Control Module

2	Reverse Power	synchronization active	When controller detects inverse power is over pre-set, alarm signal is sent, and alarm is displayed in LCD.
3	Loss Of Excitation	synchronization active	When controller detects negative reactive power is over pre-set, alarm signal is sent, and alarm is displayed in LCD.
4	Load Current Unbalance	Genset closed	When controller detected load current imbalance value is over pre-set, alarm signal is sent by controller, and alarm is displayed in LCD.
5	Auxiliary Input 1-9	User defined	When controller detects auxiliary input port 1-9 trip alarm and input, alarm signal is sent, and alarm is displayed in LCD.
6	Loss Of Excitation	Always active	When controller detects negative reactive power is over pre-set, alarm signal is sent, and alarm is displayed in LCD.
7	Genset Over Power	Always active	When controller detects power is over pre-set, alarm signal is sent, and alarm is displayed in LCD.
8	Inverse Power	Always active	When controller detects inverse power is over pre-set, alarm signal is sent, and alarm is displayed in LCD.
9	Mains Over Frequency	Always active	When controller detects mains frequency is over pre-set, alarm signal is sent, and alarm is displayed in LCD.
10	Mains Under Frequency	Always active	When controller detects mains frequency is under pre-set, alarm signal is sent, and alarm is displayed in LCD.
11	Mains Over Voltage	Always active	When controller detects mains voltage is over pre-set, alarm signal is sent, and alarm is displayed in LCD.
12	Mains Under Voltage	Always active	When controller detects mains voltage is under pre-set, alarm signal is sent, and alarm is displayed in LCD.
13	ROCOF Protection	Synchronization active	When controller detects the rate of change of frequency is over pre-set, alarm signal is sent, and alarm is displayed in LCD.

14	VS Protection	Synchronization active	When controller detects vector shift is over pre-set, alarm signal is sent, and alarm is displayed in LCD.
----	---------------	------------------------	------------------------------------------------------------------------------------------------------------

**NOTE \*1:** For example, if set “over current” as 110% and trip shutdown delay as one hour, when load current is over 110%, the delay begins. But when current cannot fall down within one hour, electrical trip occurs and engine stops. Higher current will cause short trip. Typically, when load current is 2 times higher than full load current, switch will open after 36 seconds, and then engine stops.

## 7 PANEL CONFIGURATION

### 7.1 LCD Display

#### 7.1.1 STATUS DISPLAY

STATUS	1-1	First Screen Display
STOP MODE		Controller Modes: STOP/MANUAL/AUTO Mode
GENSET AT REST		Genset Working Status
GB OPEN MB OPEN		Open/Closed Indication of genset/Mains
STATUS	1-2	Second Screen Display
UL-N 0 V 0.0 A		Generator Average Phase Voltage/Current
UL-L 0V 0.00Hz		Generator Average Line Voltage/Frequency
Pf = 0.00L 0.0 kW		Generator Average Power Factor, Total Active Power
STATUS	1-3	Third Screen Display
F S E123456789		F: fuel output, S: start input, E: emergency stop, auxiliary input/output 1~9
INPUT		Input port status, close/open
OUTPUT		Output port status, close/open

#### 7.1.2 ENGINE DISPLAY

ENGINE	2-1	First Screen Display
SPEED 0 RPM		Engine Speed
BATTERY 12.0 V		Start Batterer Voltage
CHARGE D+ 0.0 V		AC Charger D+ Voltage
ENGINE	2-2	Second Screen Display
OIL PRESSURE		Engine Oil Pressure

0 kPa 0.0 Bar 0 Psi	
<b>ENGINE</b> 2-3	Third Screen Display
OIL LEVEL %	Oil Level
TEMPERATURE 0°C 0 °F	Oil Temperature
<b>ENGINE</b> 2-4	Fourth Screen Display
STARTS 00000 num	Accumulated Cranking Times
HOURS RUN 0000:00:00	Accumulated Run Times: Hours/Minutes/Seconds

### 7.1.3 GENERATOR DISPLAY

<b>GENERATOR</b> 3-1	First Screen Display
UL-L 0 0 0 V	Phase Voltage L1-N L2-N L3-N
UL-N 0 0 0 V	Line Voltage L1-L2 L2-L3 L3-L1
F = 0.00Hz 0 RPM	Generator Frequency, Engine Speed
<b>GENERATOR</b> 3-2	Second Screen Display
IL 0.0 0.0 0.0 A	3 Phase Current L1 L2 L3
Pf 0.00 0.00 0.00	3 Phase Power Factor L1 L2 L3
APf 0.00L	Generator Frequency Power Factor
<b>GENERATOR</b> 3-3	Third Screen Display
kW 0.0 0.0 0.0	3 Phase Active Power L1 L2 L3
TkW 0.0 Ramp 3.0	Generator Total Active Power, Pre-Set Active Power Percentage
kW% 0.0 Tgt% 0.0	active Power Output Percentage, Object Active Power Percentage
<b>GENERATOR</b> 3-4	Fourth Screen Display
kVar 0.0 0.0 0.0	3 Phase Reactive Power L1 L2 L3
TkVar 0.0 Ramp 0.0	Total Reactive Power, Pre-Set Reactive Power Percentage
kVar% 0.0 Tgt% 0.0	Reactive Power Output Percentage , Object Reactive Power Percentage
<b>GENERATOR</b> 3-5	Fifth Screen Display
kVA 0.0 0.0 0.0	3 phase apparent power L1 L2 L3
TkVA 0.0	Total apparent power
	speed regulation voltage Output Percentage, Voltage

GOV% 0.0 AVR% 0.0	regulation Output Percentage
GENERATOR 3-6	Sixth Screen Display
kWh 0000000.0	Accumulated Active Electrical Power
kVAh 0000000.0	Accumulated Apparent Electrical Power
kVarh 0000000.0	Accumulated Reactive Electrical Power
GENERATOR 3-7	Seventh Screen Display
PHASE SEQUENCE: LN1-LN2-LN3 000-120-240°	Generator Phase-Sequence

#### 7.1.4 MAINS DISPLAY

MAINS 4-1	First Screen Display
UL-L 0 0 0 V	Mains 3 Phase Phase Voltage L1-N L2-N L3-N
UL-N 0 0 0 V	Mains 3 Phase Line Voltage L1-L2 L2-L3 L3-L1
F = 0.00Hz	Mains Frequency
MAINS 4-2	Second Screen Display
IL 0.0A	Mains Phase Current L1
Pf 0.00L	Mains Power Factor
MAINS 4-3	Third Screen Display
kW 0.0 kW% 0.0	Total Active Power, Active Power Output Percentage
kVar 0.0 kVar% 0.0	Total Reactive Power, Reactive Power Output Percentage
kVA 0.0	Mains Apparent Power
MAINS 4-4	Fourth Screen Display
PHASE SEQUENCE: LN1-LN2-LN3 000-120-240°	Mains Phase-Sequence
MAINS 4-5	Fifth Screen Display
ROCOF 0.00Hz 10.00Hz	Mains Frequency Shift
VECTOR 0.0° 64.2°	Mains Vector Shift
MAINS 4-6	Sixth Screen Display
TAKEOVER MODE	Current Genset Mode
kW 0.0% 103kW	Pre-set active power percentage, actual value
kVar 0.0%72.2kVar	Pre-set reactive power percentage, actual value

**7.1.5 SYNCHRONIZATION DISPLAY**

SYNCHROSCOPE 5-1	First Screen Display
VOLT DIFF +0.1 V ✓	Voltage difference between genset and mains
FREQ DIF +0.01 Hz ✓	Frequency difference between genset and mains
PHASE DIFF +0.1° ✓	Phase difference between genset and mains

**7.1.6 ALARMS DISPLAY**

ALARMS 6-1	First Screen Display
ALARMS:(01/02)	Total Number of Alarms
SHUTDOWN ALARM	Alarm Types: Warning/Shutdown/Trip
OP SENSOR OPEN	Alarm Description
ALARMS 6-2	Second Screen Display
ALARMS:(02/02)	Total Number of Alarms
SHUTDOWN ALARM	Alarm Types: Warning/Shutdown/Trip
GENERATOR CLOSED ERROR	Alarm Description







**7.1.7 EVENT LOG**









EVENTS 7-1	First Screen Display
RECORDS: (01/02)	Total Number of Records
OVER CURRENT TRIP	Error Types
2010-12-18 21:31:55	Record Time
EVENTS 7-2	Second Screen Display
RECORDS: (02/02)	Total Number of Records
GENERATOR CLOSED ERROR	Error Types
2010-12-18 08:11:07	Record Time

**7.1.8 ABOUT**

ABOUT 8-1	First Screen Display
MODEL:HGM6520	Model: HGM6510, HMG6520
SOFTWARE:V4.0.2	Module Software Version
11-03-08 (5) 03:11:32	Current Clock
ABOUT 8-2	Second Screen Display
HARDWARE:V1.3	Module Hardware Version
CPU TEMP:34°C/93°F	Module Inner Temperature
ISSUE DATE: 2011-06-24	Original Release

## 7.2 PARAMETERS CONFIGURATION

Press  and hold, and then pressing  can enter into the password interface. Pressing  or  can input the password, (range of 0~9),  or  to shift cursor to the left or right, and press  in the fourth to confirm. Parameter setting will be entered if password is correct, or directly exit with wrong password. (Factory default is 1234 and user can change it)

Pressing  and  can scroll screen up or down. Under current parameter screen press  and enter into the item. The first digital turns black display. Then, press  or  to increase or decrease the value, and press  or  to shift the cursor to the right or left. At last, press  to confirm this setting at the last digital.

In parameter configuration, pressing  can exit this menu directly and back to main menu.

### Parameters list:

No.	Items	Range	Default	Notes
01	Low Oil Pressure (Warning)	(1-999)kPa	124kPa/18.0PSI	Return value: 138kPa/20.0PSI
02	Low Oil Pressure (Shutdown)	(0-997)kPa	103kPa/14.9PSI	Setting standard: shutdown<warn <return
03	High Temperature (Warning)	(81-139)°C	93°C/194°F	Return value: 88°C/190°F
04	High Temperature (Shutdown)	(82-140)°C	98°C/203°F	Setting standard: shutdown>warn >return
05	Low Fuel Level (Warning)	(0-100)%	10%	Analog value
06	Start Delay	(0-9999)s	5s	Timer
07	Preheat Delay	(0-300)s	0s	Timer
08	Crank Time	(3-60)s	8s	Timer
09	Crank At Rest	(3-60)s	10s	Timer

HGM6520 Automatic Control Module

No.	Items	Range	Default	Notes
10	Safety On Timer	(5-60)s	10s	Timer
11	Over Speed/Shoot Time	(0-10)s	2s	Timer
12	Start Idle Timer	(0-3600)s	10s	Timer
13	Warm Up Timer	(0-3600)s	30s	Timer
14	Stop Delay	(0-9999)s	30s	Timer
15	Cooling Timer	(0-3600)s	60s	Timer
16	Stop Idle Timer	(0-3600)s	10s	Timer
17	ETS Solenoid Hold Time	(0-120)s	0s	Timer
18	Over Stop Delay	(10-120)s	30s	Timer
19	Genset Transient Delay	(0-30)s	5s	Timer
20	Battery Low Voltage Delay	(0-9999)s	60s	Timer
21	Battery Over Voltage Delay	(0-9999)s	60s	Timer
22	Inverse Power Delay	(0-300)s	10s	Timer
23	Genset Low Volt (Warning)	(50-360)V	196V	Load value: 207V Setting standard: Shutdown <warning <load.
24	Genset Low Volt (Shutdown)	(50-360 )V	184V	Under voltage shutdown
25	Genset Over Volt (Warning)	(50-360)V	265V	Return value:253V
26	Genset Over Volt (Shutdown)	(50-360)V	273V	Setting standard: shutdown <warning <return
27	Genset Low Freq (Warning)	(0.1-74.9)Hz	42.0Hz	Load value:45.0Hz Setting standard: Shutdown <warning <load.
28	Genset Low Freq (Shutdown)	(0-74.8)Hz	40.0Hz	Under frequency shutdown
29	Genset High Freq (Warning)	(0.1-74.9)Hz	55.0Hz	Return value:52.0Hz
30	Genset High Freq (Shutdown)	(0.2-75)Hz	57.0Hz	Setting standard: shutdown>warn >return



HGM6520 Automatic Control Module

No.	Items	Range	Default	Notes
31	Over Current Percentage	(50-120)%	100%	Analogy Value
32	Flywheel Teeth	(10-500)	118	Used for detecting crank disconnection.
33	Under Speed (Warning)	(1-5999)RPM	1350RPM	Return value: 1380RPM Setting standard: Shutdown <warning <load.
34	Under Speed (Shutdown)	(0-5998)RPM	1270RPM	Under speed shutdown
35	Over Speed (Warning)	(1-5999)RPM	1650RPM	Return value: 1620RPM
36	Over Speed (Shutdown)	(2-6000)RPM	1710RPM	Setting standard: Shutdown >warn >return
37	Over Speed/ Shoot Percent	(0-10)%	10	Analogy Value
38	Battery Low Volt (Warning)	(0-39.9)V	8.0V	Analogy Value
39	Battery Over Volt (Warning)	(0.1-40)V	33.0V	Analogy Value
40	Charge Failure (Warning)	(0-39)V	6.0V	Analogy Value
41	Language Select	(0-1)	0	0:Chinese 1:English
42	Password	(0-9999)	1234	Numerical Value
43	Module Priority	(0-19)	0	Upper to lower
44	Module Address(RS485)	(1-254)	1	RS485 communication address
45	Current Transformer	5-6000:5A	500A	Load Current: 500A
46	Rated Active Power	(0-9999)	345	kW
47	Rated Reactive Power	(0-9999)	258	kVar
48	Load Slope	(0-100)%	3%	Ramp-up/ramp-down to load of genset
49	Full Power Start	(0-100)%	80%	For scheduling unit to start.
50	Low Power Shutdown	(0-100)%	50%	For scheduling unit to stop.

HGM6520 Automatic Control Module

No.	Items	Range	Default	Notes
51	Synch Positive Freq Difference	(0-2)Hz	0.2Hz	Frequency difference of genset and mains. If within the range, frequency is synchronous.
52	Synch Negative Freq Difference	(0-2)Hz	0.1Hz	
53	Synch Voltage Difference	(0-20)V	3V	Voltage difference of genset and mains.
54	Synch Phase Difference	(0-20)°	10°	Phase difference of genset and mains.
55	Fail to Synchronize Delay	(5-300)s	60s	If synchronization is over preset delay, an alarm will be initiated.
56	MSC Baud Rate	0:330k, 1:250k, 2:125k	0	Baud rate of MSC module.
57	Mains Transient Delay	(0-30)s	2s	Mains normal or abnormal delay
58	Mains Under Volt	(50-360)V	184V	Mains under voltage
59	Mains Over Volt	(50-360)V	276V	Mains over voltage
60	Mains Under Freq	(0-75)Hz	45Hz	Mains under frequency
61	Mains Over Freq	(0-75)Hz	55Hz	Mains over frequency





**Other parameters configuration (only configured by software via PC)**

Items	Default
Module Address	1
Alternator Select	Yes
Number of Poles	4
Magnetic Pickup Sensor Select	Yes
Start Times	3
Voltage Transformer	No
Fuel Pump Control	No
Digit Input 1	Remote start on load, close to activate
Digit Input 2	Low oil pressure alarm, close to activate, active from safety on timer.
Digit Input 3	High temperature alarm, close to activate, active from safety on timer.
Digit Input 4	Closed generator auxiliary input, close to activate
Digit Input 5	Indication, close to activate
Digit Input 6	Working mode select, close to activate
Digit Input 7	Indication, close to activate
Digit Input 8	Indication, close to activate

HGM6520 Automatic Control Module

Digit Input 9	Indication, close to activate
Digit Output 1	Genset normal voltage
Digit Output 2	Common alarm
Digit Output 3	Idle/high-speed control
Digit Output 4	Closed generator output
Digit Output 5	Open generator output
LED1	System in automatic mode
LED2	Fail to start alarm
LED3	Common shutdown alarm
LED4	Common alarm
Overload Current Delay Timer	100%(500A)
Delay Rate	36
Action (Over Current)	Electrical trip
Genset Frequency (Starter Disconnect)	15Hz
Engine Speed (Starter Disconnect)	450RPM
Oil Pressure (Starter Disconnect)	Not used
Detect Oil Pressure During Cranking	No
Scheduled Start/Stop	No
Mains Splitting	R.O.C.O.F: 0.2Hz/s V.S: 6.0° Mains under volt: 209V, 0.1s delay Mains over volt: 253V, 0.1s delay Mains under frequency: 47.1Hz, 0.1s delay Mains over frequency: 50.5Hz, 0.1s delay
MSC ID	0
GOV	0V
AVR	0V
Frequency Synchronization PID	Configured by HGM6500 software
Voltage Synchronization PID	
Active Power PID	
Reactive power PID	

## 7.3 DATE/TIME CONFIGURATION

Press  key and  key simultaneously and enter into date/time configuration. The first digital of the fourth row is black display. Press  or  to input corresponding number (range of 0~9), pressing “√” can shift to the right, “√” again at last to confirm, and then date and time has been restored and exit. Press  to exit directly without saving.

The date/time configuration order:

Year/ Month/Date/ (Week)/ Hour/Minute/Second

**NOTE:** Parameters and the date/time configuration must be in **STOP** mode.

## 7.4 Data Display

### 7.4.1 BASIC DISPLAY

Engine Speed

Oil Pressure

Engine Temperature

Fuel Level

Start Battery Voltage

Charger Voltage

Engine Hours Run

Engine Start Times

Generator Phase Voltage (L1-N, L2-N, L3-N)

Generator Line Voltage (L1-L2, L2-L3, L3-L1)

Generator Frequency

Generator Current (L1, L2, L3)

Generator Single Phase Active Power (L1, L2, L3)

Generator 3 Phase Total Active Power

Each Phase Power Factor (L1, L2, L3)

Average Power Factor

Generator Single Phase Reactive Power (L1, L2, L3)

Generator 3 Phase Total Reactive Power

Generator Accumulative Total Active/Reactive/Apparent power

Generator Phase Sequence

Mains Phase Voltage (L1-N, L2-N, L3-N)

Mains Line Voltage (L1-L2, L2-L3, L3-L1)

Mains Total Active Power

Mains Total Reactive Power  
 Mains Total Apparent Power  
 Rate of Change of Frequency (R.O.C.O.F)  
 Vector Shift (VS)  
 Mains Frequency  
 Mains Phase Sequence

#### 7.4.2 ECU DISPLAY

Oil Temperature  
 Coolant Pressure  
 Inlet Temperature  
 Exhaust Temperature  
 Supercharger Temperature  
 Fuel Pressure  
 Fuel Consumption  
 Total Fuel Consumption

## 8 INPUT AND OUTPUT PORTS DEFINITION

### 8.1 CONFIGURABLE INPUT 1-9

No	Type	Description
0	User Defined	<p>The input is configured to perform an auxiliary function, this may be any of the following:</p> <p><b>Indication:</b>(annunciation only, not alarm or shutdown)  <b>Warning:</b>(Alarm only, not shutdown)  <b>Shutdown:</b>(Alarm and shutdown)  <b>Electrical Trip:</b>(Alarm/off-load generator followed by shutdown after cooling)  <b>Never active:</b> This switches off the input if not in use.  <b>Always active:</b> The input selected to be an indication or alarm even when the module is in the STOP/RESET MODE.  <b>Active from starting:</b> The Auxiliary input is only active once an attempt to start the generator is made. It will remain active until the generator is at rest again.  <b>Active from safety on:</b> Auxiliary inputs are only active once safety on timer is over.</p>
1	Alarm Mute	When active, this will disable an output configured to 'audible alarm', without resetting the module's

HGM6520 Automatic Control Module

		alarm condition.
2	Reset Alarm	When an alarm is active, it will be cleared.
3	AC Frequency Select (50/60Hz)	Reserved
4	AC Voltage Select	For some EFI engines with CANBUS
5	Auto Return Inhibit	In AUTO mode, after the normal operation of generator, when input is active, automatic shutdown is not allowed.
6	Auto Start Inhibit	In AUTO mode, when input is active, automatic startup is not allowed.
7	Mains Failure Auxiliary Input	(Reserved)
8	Genset Closed Auxiliary Input	Connect to auxiliary contacts of genset with load switch.
9	Genset On Load Inhibit	When input is active, closed generator will be inhibited.
10	Droop Enable	Only for some EFI engines with CANBUS, when active, allow to droop.
11	Lamp Test	When input is active, all LED indicators will illuminate.
12	Mains Closed Auxiliary Input	Connect to auxiliary contacts of mains with load switch
13	Mains On Load Inhibit	(Reserved)
14	Panel Lock	When the input is effective, not all keys on its function
15	Remote Start (Unload )	In AUTO mode, when input is active, genset can be automatically started to normal operation. When inactive, genset can be stopped.
16	Remote Start (On-Load )	In automatic mode, when input is active, genset can be automatically started to normal operation and divided into the bus, only when inactive, genset can be stopped.
17	Remote Start On Load (Demand)	In AUTO mode, when input is active, all the synchronous units are started according to PRI. Then according to the load, units automatically increase or decrease units.
18	Scheduling Run Inhibit	In AUTO mode, when input is active, regular start is inhibited
19	Analog Mains Active	Reserved
20	Analog Automatic Key	An outside push button (not self-locking ) can be connected and analog panel buttons operation
21	Analog Manual Key	
22	Analog Shutdown Key	
23	Analog Test Key	

24	Analog Start Key	
25	Analog Closed Key	
26	Analog Open Key	
27	MSC Alarm Inhibit	When the MSC disconnect or data error occurs, prohibit sending a warning signal.
28	Working Mode Select	When input is active, the highest priority.
29	Reset Maintenance Alarm	When input is active, controller will reset maintenance time as default values and alarm is cleared.
30	Remote Island Start	When input is active, start mode is island mode
31	Mains Synchronization Mode	Reserved
32	Speed Up Input	Reserved
33	Speed Down Input	Reserved
34	Voltage Up Input	Reserved
35	Voltage Down Input	Reserved
36	Black Start Input	Reserved
37	Auto Mode Input	When the input is active, controller is in automatic mode and other modes are inactive.
38	Shutdown Alarm Inhibit	When the input is active, all the alarms are inactive.
39	Reserved	

**NOTE:** Configurable input 1-9 cannot be defined as same item (Not Used and User Defined excluded), otherwise incorrect function will occur.

## 8.2 CONFIGURABLE OUTPUT 1-5

Each output port has the same option; and can be defined as the same content.

No	Type	Description
00	Not Used	
01	Air Flap Relay	In Emergency Stop or Over-speed alarm, stop engine to let air in.
02	Audible Alarm	This output is intended to drive an external Klaxon or alarm indicator and will be active upon the module triggering a warning, shutdown or electrical trip alarm. This external alarm can be “muted”, without resetting the module’s alarm condition by activating an auxiliary input that has been configured to “Mute Alarm”.
03	Battery High Volt	This output indicates that a Battery High Voltage alarm has occurred.
04	Battery Low Volt	This output indicates that a Battery Low Voltage alarm has occurred.
05	Digit Input 7 Active	This output indicates that digital input 7 is active.
06	Digit Input 8 Active	This output indicates that digital input 8 is active.
07	Digit Input 9 Active	This output indicates that digital input 9 is active.

HGM6520 Automatic Control Module

No	Type	Description
08	Start Relay Output	The output mimics the operation of the start relay. Can be used to control external logic circuitry.
009	Fuel Relay Output	The output mimics the operation of the fuel relay. Can be used to control external logic circuitry.
010	Scheduling Start	When activated scheduling start and unit operation output(Automatic mode is active)
011	Charge Failure	Charging failure, generator warning alarm.
012	Genset Closed Output	Can control power switch with load.(continuous)
013	Genset Pulse Closed Output	Generator pulse closed output; the output closed time is controlled by pulse time.
014	Mains Closed Output	Can control the mains switch with load.
015	Mains Pulse Closed Output	Mains pulse closed output; the output closed time is controlled by pulse time.
016	Common Under/Over Freq Shutdown	When under frequency and over frequency shutdown alarm has occurred.
017	Common Under/Over Freq Warning	When under frequency and over frequency shutdown warning has occurred.
018	Common Under/Over Volt Shutdown	When under voltage and over voltage shutdown alarm has occurred.
019	Common Under/Over Volt Warning	When under voltage and over voltage warning alarm has occurred.
020	Common Alarm	Generator common warning, common shutdown, common electrical trip alarm.
021	Common Trip	When common trip alarm is active
022	Common Shutdown	When Common shutdown alarm is active
023	Common Warning	When Common warning alarm is active
024	High Temperature 1 Warning	High water/cylinder temperature warning alarm has occurred
025	High Temperature 1 Shutdown	High water/cylinder temperature shutdown alarm has occurred
026	Cooling Delay Timer	When the cooling time delay is active
027	Synchronization Detect Output	When the synchronous outputs is active
028	Digit Input 1 Active	This output indicates that digital input 1 is active.
029	Digit Input 2 Active	This output indicates that digital input 2 is active.
030	Digit Input 3 Active	This output indicates that digital input 3 is active.
031	Digit Input 4 Active	This output indicates that digital input 4 is active.
032	Digit Input 5 Active	This output indicates that digital input 5 is active.
033	Digit Input 6 Active	This output indicates that digital input 6 is active.
034	Emergency Stop	This output indicates that an Emergency stop alarm has occurred.
035	ETS Shutdown	When in ETS solenoid shutdown delay



HGM6520 Automatic Control Module

No	Type	Description
	Output	
036	Fail To Start Alarm	Starting failure alarm
037	Fuel Pump Control	Controlled by fuel level
038	Genset Active	During normal operation and high cooling timer
039	Genset Over Frequency Warning	Generator over frequency warning has occurred.
040	Genset Over Frequency Shutdown	Generator over frequency alarm has occurred.
041	Genset Over Voltage Warning	Generator over voltage warning has occurred.
042	Genset Over Voltage Shutdown	Generator over voltage shutdown has occurred.
043	Genset Under Frequency Warning	Generator owe frequency warning has occurred.
044	Genset Under Frequency Shutdown	Generator owe frequency shutdown has occurred.
045	Genset Under Voltage Warning	Generator owe voltage warning has occurred.
046	Genset Under Voltage Shutdown	Generator owe voltage shutdown has occurred.
047	Louver Control	The output controls the opening of the louvers on engine starting and closure when engine has stopped.
048	Low Fuel Level	This output indicates that the level of fuel has fallen below the low fuel alarm trip point.
049	Loss Of Speed Signal	In the safe operation, engine speed detection equals 0 actions.
050	Mains Abnormal	Mains over frequency, under frequency, over-voltage, under voltage, auxiliary mains active when abnormal.
051	Mains Over Frequency	This output indicates that the module has sensed that the incoming AC mains supply has exceeded the frequency limit setting.
052	Mains Over Voltage	This output indicates that the module has sensed that the incoming AC mains supply voltage has exceeded the voltage limit setting.
053	Mains Under Frequency	This output indicates that the module has sensed that the incoming AC mains supply has fallen below the set frequency.
054	Mains Under Voltage	This output indicates that the module has sensed that the incoming AC mains supply voltage has fallen below the voltage limit setting.
055	Low Oil Pressure 1 Warning	A low oil pressure warning has occurred.

HGM6520 Automatic Control Module

No	Type	Description
056	Low Oil Pressure 1 Shutdown	A low oil pressure shutdown has occurred.
057	Oil Pressure Sensor Open	This output indicates that the module has detected an open circuit failure in the Oil Pressure transducer circuit.
058	Open Genset Output	This output source is intended to be used to control the load switching device. Whenever the HGM6510 module selects the mains to be on load this control source will be active.
059	Genset Pulse Open Output	This output source is intended to be used to control the load switching device. Whenever the HGM6510 module selects the mains to be on load, this control source will be active for the duration of the "Breaker open Pulse Timer".
060	Mains Open Output	This output source is intended to be used to control the load switching device. Whenever the HGM6510 module selects the generator to be on load this control source will be active.
061	Mains Pulse Open Output	This output source is intended to be used to control the load switching device. Whenever the HGM6510 module selects the generator to be on load this control source will be active for the duration of the "Breaker open Pulse Timer".
062	Over Current Warning	This output indicates that the over-current warning level has been reached.
063	Over Current Trip	This output indicates that the over-current trip level has been reached.
064	Over Speed Warning	This output indicates that an over speed warning has occurred.
065	Over Speed Shutdown	This output indicates that an over speed shutdown has occurred.
066	Preheat Timer (Until Cranking)	The output controls the pre-heater. Preheat output is available for the duration of the preheat timer, which terminates prior to cranking.
067	Preheat Timer (Until End Of Cranking)	The output controls the pre-heat. As Pre-heat (during preheat timer) mode but pre-heat is also available during cranking.
068	Preheat Timer (Until End Of Warm Up)	The output controls the pre-heater. As Pre-heat (until safety on) but pre-heat continues to be available until the warm-up timer has elapsed.
069	Preheat Timer (Until End Of Safety On)	The output controls the pre-heater. As Pre-heat (until end of cranking) but pre-heat is also available while waiting for the delayed alarms to become active.

HGM6520 Automatic Control Module

No	Type	Description
070	Open Breaker Output	This output source is intended to be used to control the load switching device. Whenever the HGM6510 module has taken load, this control source will be active.
071	System In Manual Test Mode	This output indicates that the module is in the test mode.
072	System In Auto Mode	The output indicates that the module is in the Auto mode.
073	System In Manual Mode	This output indicates that the module is in the manual mode.
074	System In Stop Mode	The output indicates that the module is in the stop mode.
075	Under Speed Warning	This output indicates that an under speed warning (pre-alarm) has occurred.
076	Under Speed Shutdown	This output indicates that an under speed shutdown has occurred.
077	Reserved	
078	Idle/Hi-Speed Control	This output is active from cranking, continues to be active until the "start idle" timer has elapsed; Also this output is active during the period of the stop idle timer, continues to be active until the engine has stopped.
079	Pre-Oil Supply Output	During the safe operation or in starting when action.
080	Speed Up Output	Reserved
081	Magnetizing Output	Output when started. During safety on running, output 2 seconds without generator frequency.
082	Speed Down Output	Reserved
083	Pre-Lubrication Output	Active during preheat to safety on running.
084	Voltage Up Output	Reserved
085	Voltage Down Output	Reserved
086	Inverse Power Output	Generators inverse power than the setting time delay output.
087	Over Power Output	Generator set power than the setting time delay output
088	Low Temperature Warning	Outputting when water temperature is lower.
089	Genset Voltage Normal	Volt, freq of generator is within threshold
090	ECU Power	Use for ECU engine to control its power.
091	ECU Stop	Use for ECU engine to control its stop.

**NOTE: Functions of output 1~5 only can be configured by PC software.**

## 9 ENENT LOG

HGM6520 controller can maintain a log of max. 99 shutdown alarms, along with the date/time, to enable the operator to view the past alarms history. Only shutdown and electrical trip alarms are logged; warning alarms are not logged. Once the log is full (99 shutdown alarms), any subsequent shutdown alarms will overwrite the oldest entry in the log. Hence the log will always contain the 99 most recent shutdown alarms.

## 10 REAR PANEL

HGM6520 controller rear panel is configured as following,

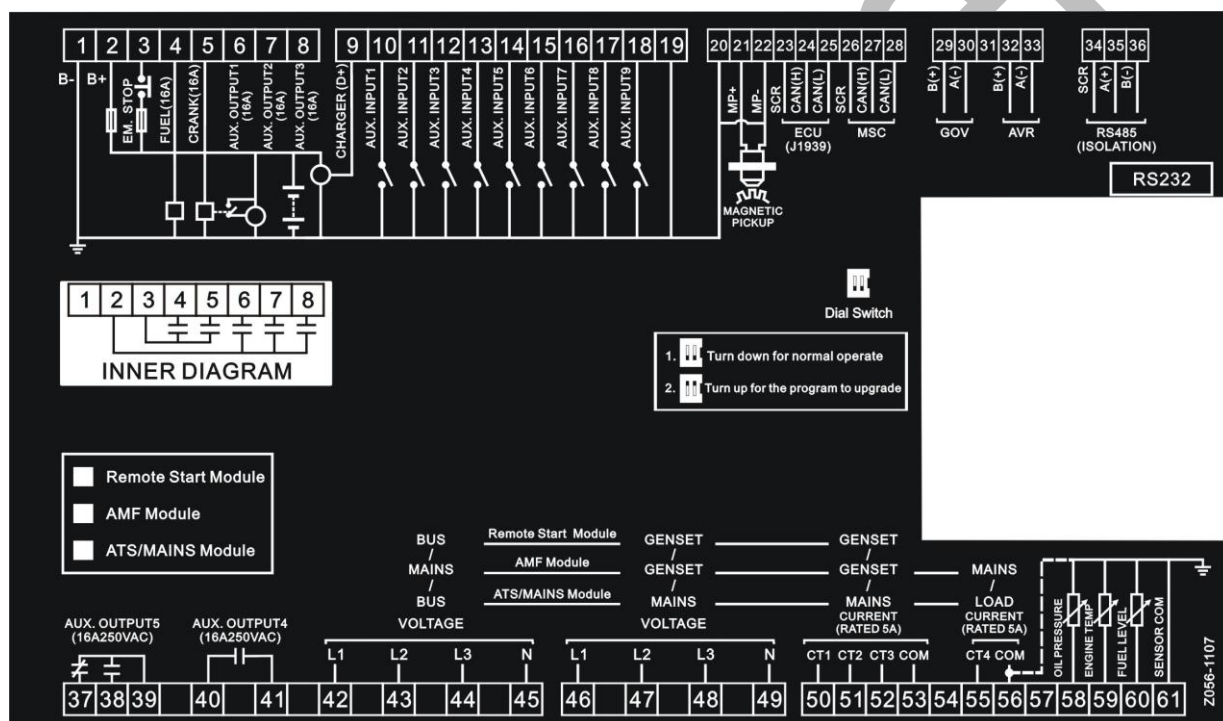

Terminal connections on rear panel are as below,

Pin	Function	Cable Size	Description
1	DC Plant Supply (B-)	2.5mm <sup>2</sup>	System DC negative input. (Battery Negative).
2	DC Plant Supply (B+)	2.5mm <sup>2</sup>	System DC positive input. (Battery Positive). Recommended max. Fuse 20A
3	Emergency Stop	2.5mm <sup>2</sup>	Plant Supply B+. Also supply fuel & start relay output. Recommended max. Fuse 30A
4	Fuel Relay Output	2.5mm <sup>2</sup>	Plant Supply B+ from pin 3.

HGM6520 Automatic Control Module

Pin	Function	Cable Size	Description
			16 Amp rated.
5	Start Relay Output	2.5mm <sup>2</sup>	Plant Supply B+ from pin 3. 16 Amp rated.
6	Aux. Output 1	2.5mm <sup>2</sup>	Plant Supply B+ 16 Amp rated.
7	Aux. Output 2	2.5mm <sup>2</sup>	Plant Supply B+ 16 Amp rated.
8	Aux. Output 3	2.5mm <sup>2</sup>	Plant Supply B+ 16 Amp rated.
9	Charge Failure/Excitation	1.0mm <sup>2</sup>	The charging generator D+ input, not grounding.
10	Aux. Input 1	1.0mm <sup>2</sup>	Digital input
11	Aux. Input 2	1.0mm <sup>2</sup>	Digital input
12	Aux. Input 3	1.0mm <sup>2</sup>	Digital input
13	Aux. Input 4	1.0mm <sup>2</sup>	Digital input
14	Aux. Input 5	1.0mm <sup>2</sup>	Digital input
15	Aux. Input 6	1.0mm <sup>2</sup>	Digital input
16	Aux. Input 7	1.0mm <sup>2</sup>	Digital input
17	Aux. Input 8	1.0mm <sup>2</sup>	Digital input
18	Aux. Input 9	1.0mm <sup>2</sup>	Digital input
19	Common GND (B-)	1.0mm <sup>2</sup>	Connect to case shell or starting battery negative.
20	Magnetic Pickup Sensor SCR	1.0mm <sup>2</sup>	
21	Magnetic Pickup Sensor +	1.0mm <sup>2</sup>	Connect to speed sensor
22	Magnetic Pickup Sensor -	1.0mm <sup>2</sup>	
23	CANJ1939 SCR	0.5mm <sup>2</sup>	
24	CAN J1939 Data (H)	0.5mm <sup>2</sup>	Recommended 120Ω screen
25	J1939 Data (L)	0.5mm <sup>2</sup>	
26	MSC SCR	0.5mm <sup>2</sup>	Recommended 120Ω screen to connect HGM6520 controller all together.
27	MSC (H)	0.5mm <sup>2</sup>	
28	MSC (L)	0.5mm <sup>2</sup>	
29	GOV Wire B (+)	1.0mm <sup>2</sup>	Recommended 2-core shielded wire, the grounding in GOV.
30	GOV Wire A (-)	1.0mm <sup>2</sup>	
31	Not Used		
32	AVR Voltage Wire B(+)	1.0mm <sup>2</sup>	Recommended 2-core shielded wire, the grounding in AVR.
33	AVR Voltage Wire A(-)	1.0mm <sup>2</sup>	
34	RS485 SCR	0.5mm <sup>2</sup>	
35	RS485+ (A)	0.5mm <sup>2</sup>	PC programming or monitoring interface (coupler isolated), grounding at one end.
36	RS485- (B)	0.5mm <sup>2</sup>	

HGM6520 Automatic Control Module

Pin	Function	Cable Size	Description
37 38 39	Aux. Output 5	2.5mm <sup>2</sup>	Relay normally open/closed passive contact, 16A current rated
40 41	Aux. Output 4	2.5mm <sup>2</sup>	Relay normally open contact, 16A current rated.
42	Mains A Phase Voltage Sensing	1.0mm <sup>2</sup>	Connected to mains A Phase (Recommend 2A fuse).
43	Mains B Phase Voltage Sensing	1.0mm <sup>2</sup>	Connected to mains B Phase (Recommend 2A fuse).
44	Mains C Phase Voltage Sensing	1.0mm <sup>2</sup>	Connected to mains C Phase (Recommend 2A fuse).
45	Mains Neutral Input	1.0mm <sup>2</sup>	Connected to Neutral.
46	Generator A Phase Voltage Sensing	1.0mm <sup>2</sup>	Connected to generator A Phase output (Recommend 2A fuse).
47	Generator B Phase Voltage Sensing	1.0mm <sup>2</sup>	Connected to generator B Phase output (Recommend 2A fuse).
48	Generator C Phase Voltage Sensing	1.0mm <sup>2</sup>	Connected to generator C phase output (Recommend 2A fuse).
49	Generator Neutral Input	1.0mm <sup>2</sup>	Connected to Neutral.
50	Current Transformer A Phase Sensing	2.5mm <sup>2</sup>	External current transformer secondary (Maximum 5A).
51	Current Transformer B Phase Sensing	2.5mm <sup>2</sup>	External current transformer secondary (Maximum 5A).
52	Current Transformer C Phase Sensing	2.5mm <sup>2</sup>	External current transformer secondary (Maximum 5A).
53	Current Transformer Common	2.5mm <sup>2</sup>	External CT common port and the port must connect battery negative or grounding.
54	Not Used		
55 56	Mains A Phase CT Sensing	2.5mm <sup>2</sup>	External current transformer secondary (Maximum 5A). HGM6520 ONLY.
57	Not Used		
58	Pressure Sensor Input	1.0mm <sup>2</sup>	External a resistor sensor.
59	Temp Sensor Input	1.0mm <sup>2</sup>	External a resistor sensor.
60	Fuel Level Sensor Input	1.0mm <sup>2</sup>	External a resistor sensor.

Pin	Function	Cable Size	Description
61	Sensor Common	1.0mm <sup>2</sup>	Sensor common port, connect chassis or starting battery cathode.
	RS232 Port		PC programming or monitor the interface, cannot use with RS485 at the same time.
	DIP Switch	2-bit	Update program: 1.Up-dial for normal use; 2.Down-dial for upgrading program

## 11 ECU INTERFACE

**HGM6520** controller has engine ECU interface. Because different manufactories have different ports and communication protocols, please check if the controller is suitable for your engine.

This controller can monitor and control some electrical parameters of engine, such as speed, oil pressure, temperature and so on. These parameters can be monitored by standard communication interface without installing sensors, which can reduce connection wirings in engine and enhance high reliability.

## 12 COMMISSIONING PROCEDURE

### 12.1 Step1- Single Unit Commissioning

- 1) Check the parameter configuration of the controller;
- 2) Check the connections between the units.
- 3) Start the unit manually, check if the data of the generator and engine is normal;
- 4) Start the unit manually, check if the switching on and off are normal;
- 5) Manual start and switch on, see if genset frequency can be adjusted to the rated frequency (52Hz/48Hz);
- 6) Manual start and switch on, see if genset voltage can be adjusted to the rated voltage (240V/220V);
- 7) Manual start (on-load), see if power factor, active power and reactive power is normal. If there is negative value, check the phase sequence of voltage and current, line direction of current transformer and dotted terminal of CT secondary current;
- 8) Manual start, do performance tests according to the standard.

**Note: Please refer to HGM6500 Synchronization Plan List for more information on GOV and AVR setting.**

## **12.2 Step 2- Manual Synchronization (no-load)**

- 1) Set the controller as generator control mode, active power as 0% and reactive power as 0%;
- 2) After no-load synchronization, see if genset active power and reactive power is 0.

## **12.3 Step 3- Manual Synchronization (on-load)**

- 1) Set the controller as generator control mode, active power as 50% and reactive power as 20%;
- 2) After manual synchronization, see if genset active power is 50% and reactive power is 20%.



## 13 MAINS SYNCHRONIZATION MODE

### 13.1 Genset Control Mode

Fixed power

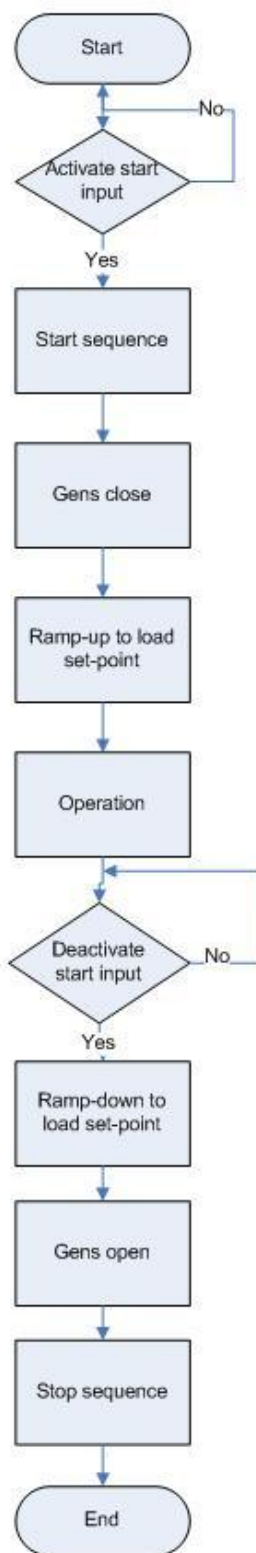

### 13.2 Mains Control Mode

Once over the set value, genset will share the spare power. Connect CT.

#### Peak shaving

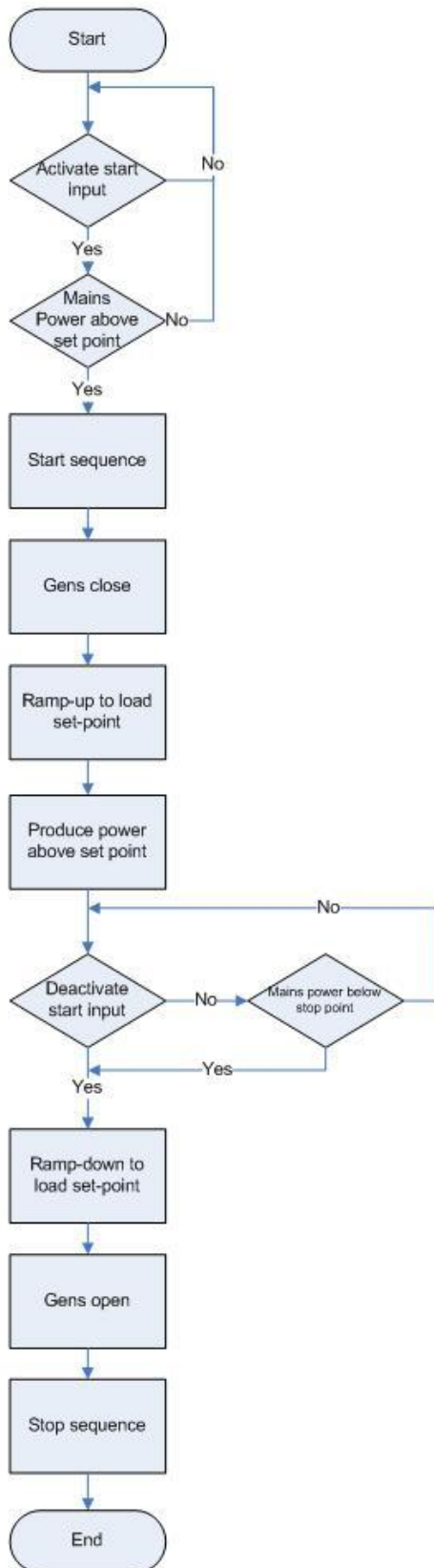

### 13.1 Load Takeover Mode

Load takeover mode need to connect CT.

#### Load Takeover

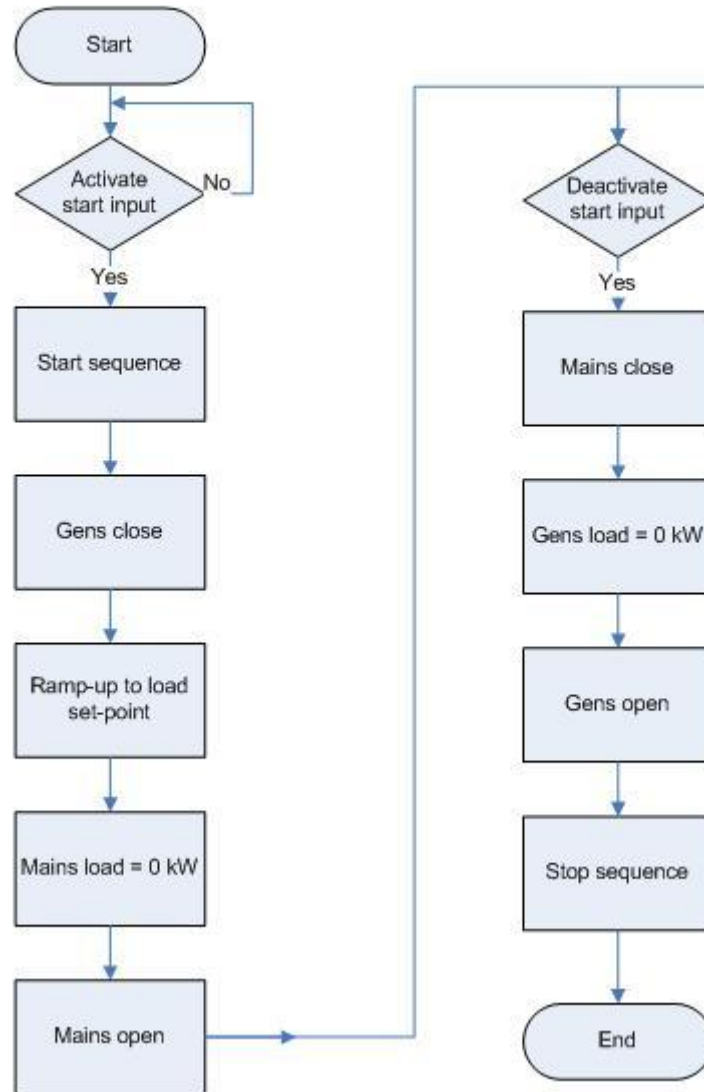

13.1 AMF Mode

Automatic Mains Failure

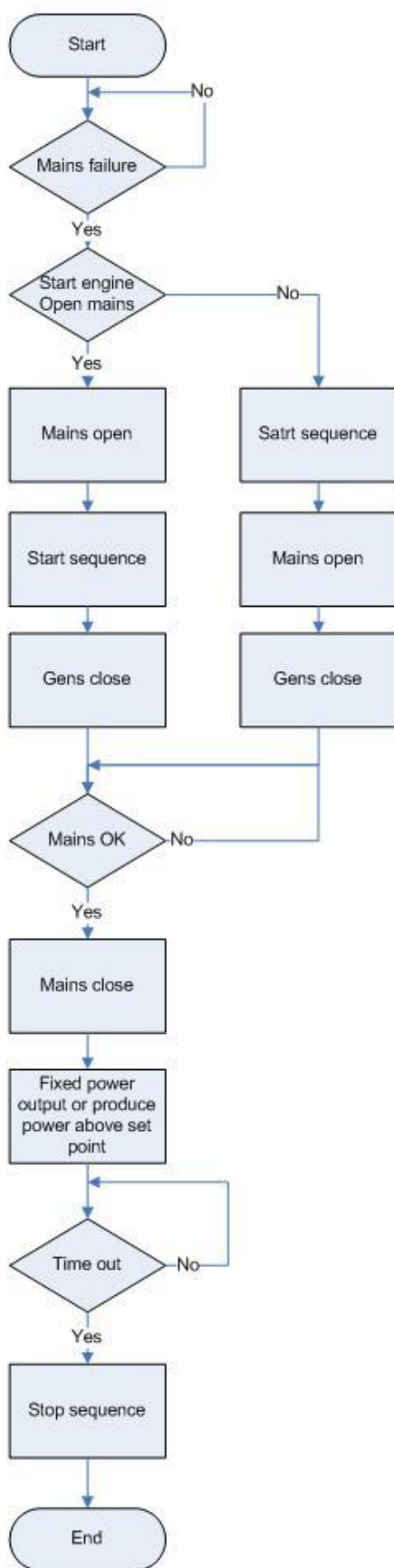

### 13.1 Island Mode

#### Single generator island operation

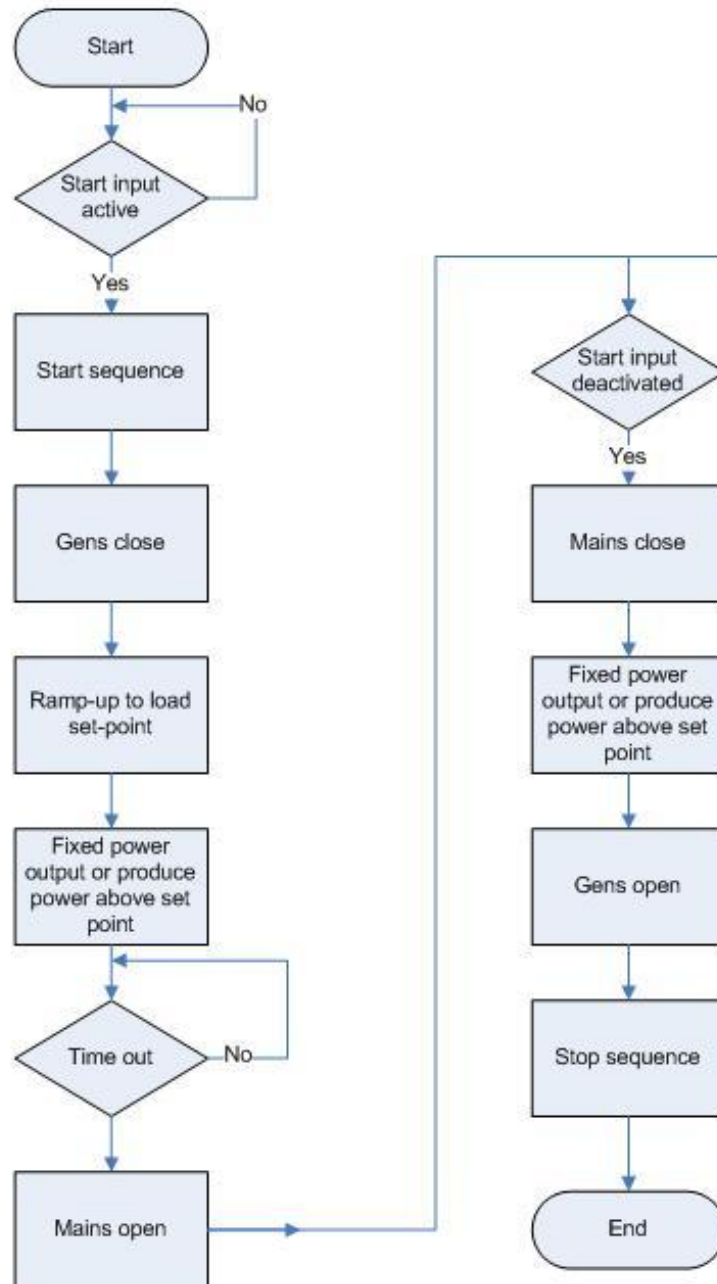

## 14 FAULT FINDING

Symptom	Possible Remedy
Controller Inoperative After Powered	Check starting battery; Check controller connections; Check DC fuse.
Genset Stops	Check the water/cylinder temperature; Check the voltage of AC alternator; Check DC fuse.
Emergency Stop	Check is the emergency stop button is correct; Check if the starting battery anode is correctly connected to the emergency stop input; Check if the connection is open circuit.
Low OP Alarm After Crank Disconnect	Check the oil pressure sensor and its connections.
High Engine Temperature Alarm After Crank Disconnect	Check the temperature sensor and its connections.
Shutdown During Running	Check related switches and connections according to LCD information; Check configurable input port.
Genset Closing Fault	Check auxiliary input port; Check closing relay of genset.
Reverse Phase Sequence	Check phase-sequence of the generator voltage.
Bus Reverse Phase Sequence	Check phase sequence of bus voltage.
Fail To Start	Check fuel circuit and its connections; Check starting battery; Check speed sensor and its connections; Refer to engine manual.
Starter No Response	Check the connections of starter; Check starting battery;
Not Closing During Genset Running	Check switch; Check the connection between switch and controller; Check whether the "Inhibit Genset Load" is

## 15 TYPICAL APPLICATION

### HGM6520 typical wiring diagram

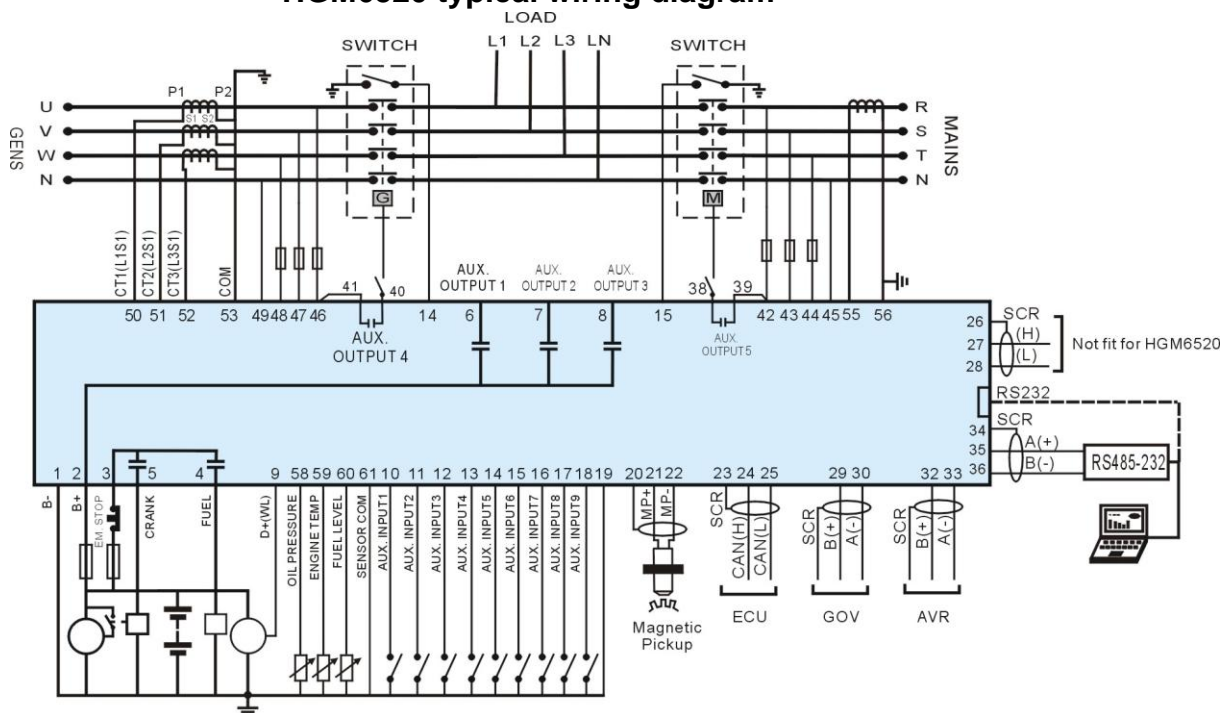

Expand high-capacity relays in start & fuel output ports are recommended.

## 16 COMMUNICATION INTERFACE

This controller provides standard RS232 and RS485 communication interface, so computer can directly (or through a modem) communicate with controller, to achieve remote start/stop and monitoring data, etc.

RS232/485 interface uses MODBUS-RTU communication protocol. This agreement belongs to master-slave agreement and controller is slave. When controller receives request from host (PC or monitoring host), it sends data to the host according to specified format. Controller never actively sends data to the host.

## 17 CASE DIMENSIONS AND PANEL CUTOUT

