

# SmartGen

MAKING CONTROL SMARTER

## HAT828

### HIGH SPEED ATS CONTROLLER

### USER MANUAL



郑州众智科技股份有限公司  
SMARTGEN(ZHENGZHOU)TECHNOLOGY CO.,LTD.

**SmartGen**众智 Chinese trademark

**SmartGen** English trademark

**SmartGen** – make your generator *smart*

**SmartGen Technology Co., Ltd.**

**No.28 Jinsuo Road, Zhengzhou, Henan Province, China**

**Tel:** +86-371-67988888/67981888/67992951

+86-371-67981000(overseas)

**Fax:** +86-371-67992952

**Email:** [sales@smartgen.cn](mailto:sales@smartgen.cn)

**Web:** [www.smartgen.com.cn](http://www.smartgen.com.cn)

[www.smartgen.cn](http://www.smartgen.cn)

All rights reserved. No part of this publication may be reproduced in any material form (including photocopying or storing in any medium by electronic means or other) without the written permission of the copyright holder.

Applications for the copyright holder's written permission to reproduce any part of this publication should be addressed to Smartgen Technology at the address above.

Any reference to trademarked product names used within this publication is owned by their respective companies.

SmartGen Technology reserves the right to change the contents of this document without prior notice.

**Table 1 – Software Version**

Date	Version	Note
2021-06-01	1.0	Original release.
2022-07-08	1.1	Update the Logo of SmartGen; update the figure of clips installation.

## CONTENT

1	OVERVIEW.....	5
2	PERFORMANCE AND CHARACTERISTICS.....	6
3	SPECIFICATION.....	8
4	MEASURE AND DISPLAY DATA.....	10
5	OPERATION.....	11
5.1	INDICATORS.....	11
5.2	KEY FUNCTION DESCRIPTION.....	12
6	LCD DISPLAY.....	13
6.1	MAIN SCREEN.....	13
6.2	STATUS DESCRIPTION.....	14
6.3	MAIN MENU.....	17
7	START/STOP OPERATION.....	18
7.1	MANUAL START/STOP.....	18
7.1.1	PANEL START/STOP.....	18
7.1.2	REMOTE COMMUNICATION START/STOP.....	18
7.2	AUTO START/STOP.....	19
7.2.1	START CONDITIONS.....	19
7.2.1.1	INPUT START.....	19
7.2.1.2	GEN START MAINS NG.....	19
7.2.2	TWO GENSETS START/STOP.....	19
7.2.3	SCHEDULED RUN.....	20
7.2.4	SCHEDULED NOT RUN.....	21
8	PARAMETERS CONFIGURATION.....	22
8.1	ILLUSTRATION.....	22
8.2	PARAMETERS CONFIGURATION.....	22
8.3	DIGITAL INPUT/OUTPUT FUNCTION DESCRIPTION.....	34
8.3.1	INPUT PORTS FUNCTION DESCRIPTION.....	34
8.3.2	OUTPUT PORTS FUNCTION DESCRIPTION.....	35
8.3.3	CUSTOM COMBINED OUTPUT.....	39
9	EVENT LOG.....	40
10	BLACK BOX RECORDS.....	41
11	SWITCH OPERATION.....	42
11.1	SYNCHRONOUS TRANSFER DESCRIPTION.....	42
11.2	MANUAL OPERATION.....	42

---

11.3	AUTOMATIC OPERATION .....	45
11.3.1	ILLUSTRATION.....	45
11.3.2	AUTO TRANSFER AUTO RESTORE.....	45
11.3.3	AUTO TRANSFER NON-RESTORE.....	46
12	LOAD OUTAGE TIME DESCRIPTION .....	47
13	COMMUNICATION CONFIGURATION AND CONNECTION.....	48
13.1	ILLUSTRATION .....	48
13.2	RS485 COMMUNICATION .....	48
13.3	USB COMMUNICATION .....	48
14	TERMINALS .....	49
14.1	TERMINAL DESCRIPTION.....	49
14.2	CONTROLLER AC/DC SUPPLY DESCRIPTION .....	52
14.2.1	AC SUPPLY .....	52
14.2.2	DC SUPPLY .....	52
15	TYPICAL WIRING DIAGRAM .....	53
16	IMPORTANT TIPS.....	54
17	INSTALLATION.....	54
18	TROUBLESHOOTING.....	55

## 1 OVERVIEW

**HAT828 High Speed ATS Controller** is a dual power transfer module that can output switch transfer signals within 15ms in the case of any power outage, and synchronously transfer when both power supplies are normal. It is suitable for PC two-stage transfer switch (high speed and normal). With embedded operation system, it can precisely detect 2-way 3-phase voltage and make accurate judgment for voltage abnormal situation (over voltage, under voltage, over frequency, under frequency, loss of phase, reverse phase sequence). It also has configurable input/output, LCD display, digital communication and other functions.

**HAT828 High Speed ATS Controller** combines digitization, intelligence and networking. Automatic measurement and control can reduce incorrect operation, which is an ideal option for dual power transfer. With compact structure, advanced circuits, simple wiring and high reliability, it can be widely used in electric power, post and telecommunication, petroleum, coal, metallurgy, railways, municipal administration, intelligent building and other places with high requirements for power reliability.

## 2 PERFORMANCE AND CHARACTERISTICS

- Can complete power outage detection and control signal output within 15ms after power off; with high speed PC two-stage switch, it can realize switching within power outage 20ms;
- Suitable for PC two-stage transfer switch (normal and high speed);
- System type can set as: Mains-Gen, Gen-Mains, Mains-Mains, Gen-Gen;
- 4.3-inch single color 240x128 LCD display with white backlight, multilingual interface (Simplified Chinese, English, other), other is default as Traditional Chinese, push-button operation;
- Collect and display 2-way 3-phase voltage, frequency and phase sequence;
- Synchronous transfer when power is available on both sides (including abnormal situation);
- Display accumulated close times, auto transfer times, mains failure transfer times;
- Display current continuous supply time and S1/S2 accumulated supply time, auto transfer running time;
- With over/under voltage, over/under frequency, loss of phase, reverse phase sequence detection function;
- Auto/Manual mode transfer. In manual mode, it can manually control switch transfer;
- All parameters can be configured on site. Passwords authentication ensures authorized staff operation only;
- Manual commissioning on site to achieve genset start/stop operation;
- With switch re-closing function;
- Closing output signal can be set as pulse or continuous output;
- 2-way N-wire isolated design;
- Real-time clock (RTC); event log function (event log can record 200 items circularly);
- With black box function, can record 5 groups of events in ATS auto transfer circularly, 60 detailed data of 50s before each event record, and 10s after each event record;
- Scheduled routing run & scheduled not run (can be set as start genset once a day/week/month whether with load or not);
- Can control two gensets to work as cycle run mode, master run mode and balanced run mode;
- With customized boot screen function;
- Widely DC power supply range allows the controller can bear instantaneous DC 80V input;
- AC power supply can be phase voltage (L-N) or line voltage (L-L), supply range AC(90~576)V;
- Large terminal space allows the controller can bear maximum AC 625V voltage input;
- With Dual-RS485 isolated communication interface. With “four remote” (remote control, remote measurement, remote communication, remote adjusting) function by the ModBus-RTU communication protocol. Genset start/stop and switch transfer can be

controlled remotely;

- Suitable for various AC systems (3-phase 4-wire, 3-phase 3-wire, single-phase 2-wire, and 2-phase 3-wire methods);
- Modular design, anti-flaming ABS plastic shell, pluggable terminal, embedded mounting, compact structure with easy installation.

SmartGen

**3 SPECIFICATION**

**Table 2 – Performance Parameters**

Items	Contents	
Working Voltage	1. DC8.0V~35.0V, continuous power supply, DC reverse connection protection; 2. AC(90~576)V power supply.	
Overall Consumption	<6W (Standby mode: ≤3W)	
AC Voltage Input (PT or PT secondary side not used)	AC system	
	3P4W (L-L)	(80~625)V
	3P3W (L-L)	(80~625)V
	1P2W (L-N)	(50~360)V
	2P3W (A-B)	(80~625)V
	Voltage Resolution: 1V Accuracy: 1%	
AC Frequency	Rated: 50/60Hz Range: 15Hz~75Hz Resolution: 0.01Hz Accuracy: 0.1Hz	
S1 Close Output Port S2 Close Output Port	16A AC250V Volts free relay contacts output	
Aux. Output Port 1~4	16A AC250V Volts free output	
Aux. Output Port 5~8	10A AC250V Volts free output	
Aux. Output Port 9~10	8A AC250V Volts free output	
Digital S1, S2 Close Input	GND(B-) connected is active, low on threshold voltage is DC 1.2V, max. input voltage is DC 60V.	
Digital Input 1~8		
RS485 Interface	Isolated, half-duplex, 2400/4800/9600/19200bps baud rate can be set, Modbus-RTU communication protocol.	
USB Interface	D-type USB interface	
EMC Test Standard	Meet GB/T14048.11-2016 and IEC/EN 60947-6-1	
Vibration	5Hz~8Hz: x=±7.5mm 8Hz~500Hz: a=±2g IEC 60068-2-6	
Shock	50g, 11ms, half-sine, three consecutive shocks are applied in each of the three mutually perpendicular directions, i.e. a total of 18 times. IEC 60068-2-27	
Bump	25g, 16ms, half-sine IEC 60255-21-2	
Case Dimensions	260mmx180mmx54mm	



Items	Contents
Panel Cutout	242mmx161mm
Working Conditions	Temperature: (-25~+70)°C; Relative Humidity: (20~93)%RH
Storage Condition	Temperature: (-30~+80)°C
Protection Level	Front panel: IP65, when water proof rubber ring inserted between controller and panel; Back panel: IP20.
Insulation Strength	Apply AC2.2kV voltage between high voltage terminal and low voltage terminal; The leakage current is not more than 3mA within 1min.
Weight	1.2kg

SmartGen

**4 MEASURE AND DISPLAY DATA**

**Table 3 – Display Parameters**

No.	Measure & Display Data Items
1	S1/S2 Power Phase Voltage
2	S1/S2 Power Line Voltage
3	S1/S2 Power Voltage Phase Sequence
4	S1/S2 Power Frequency
5	Current Continuous Power Supply Time
6	Last Continuous Power Supply Time
7	S1 Accumulated Power Supply Time
8	S2 Accumulated Power Supply Time
9	QS1 Accumulated Close Times
10	QS2 Accumulated Close Times
11	Accumulated Auto Transfer Times
12	Mains Failure Transfer Times
13	Accumulated Auto Running Time
14	Synchronous Information
15	Communication Status
16	Real Time Clock
17	Alarm Information
18	Digital Input/Output Port Status
19	Event Log
20	Black Box Records

**5 OPERATION**



**Fig.1 – Panel Indication Drawing**













**5.1 INDICATORS**

**Table 4 – Indicators Description**

Indicator Type	Description
Alarm	Slow flashing (1 time per sec) when warn alarm occurs; Fast flashing (5 times per sec) when fault alarm occurs.
Auto Trans. Auto Restore/Non-restore	Green light on when it is in auto transfer/restore mode, red light on when it is in auto transfer, non-restore mode.
S1 Indicator	Light on when S1 AC power supply is normal, flashing when it is abnormal, light off when there is no power.
S1 Close Status Indicator	Light on when QS1 auxiliary contact is active, light off when it is inactive. Flashes while switching to current status.
S2 Close Status Indicator	Light on when QS2 auxiliary contact is active, light off when it is inactive. Flashes while switching to current status.
S2 Indicator	Light on when S2 AC power supply is normal, flashing when it is abnormal, light off when there is no power.
Auto Mode Indicator	Light on when current mode is Auto mode.
Manual Mode Indicator	Light on when current mode is Manual mode.
Alarm Mute Indicator	Light on when the “Alarm Mute” function is active, light off when it is removed or a new alarm is initiated.

**5.2 KEY FUNCTION DESCRIPTION**

**Table 5 – Key Function Description**







Icon	Keys	Function Description
	Auto	Switch to Auto mode.
	Manual	Switch to Manual mode.
	S1 Close	Active in Manual mode. QS1 close and S1 supply after pressing this key; S1 close can be cancelled after pressing this key when S1 waits for synchronous closing.
	S2 Close	Active in Manual mode. QS2 close and S2 supply after pressing this key; S2 close can be cancelled after pressing this key when S2 waits for synchronous closing.
	Alarm Reset	Press this key to remove fault alarm only in alarm status.
	Alarm Mute	In alarm status, press this key to mute the alarm; press again to reset.
	Restore	Auto Trans./Restore mode and Auto Trans./Non-restore mode switching.
	Lamp Test	In main screen, long press this key to test the lamp. When testing, LCD backlight is on, LCD display is all black, all LED indicators on the panel is illuminated.
	Up	In main screen, press this key to scroll up screen. In menu interface, press this key to up cursor or increase value in setting menu.
	Set/Confirm	In main screen, press this key to enter to menu. In menu screen, press this key can move cursor and confirm setting information.
	Down	In main screen, press this key to scroll down screen. In menu interface, press this key to down cursor or decrease value in setting menu.
	Return/Homepage	When setting parameters, press this key to return previous menu. In main screen, press this key to return the first screen; in other screen, press the key to return to homepage.

**NOTE:** Detailed use instructions of S1 Close key and S2 Close key please refer to [11 SWITCH OPERATION](#).

## 6 LCD DISPLAY

### 6.1 MAIN SCREEN

**Table 6 – Screen Display**

Items	Display Contents
Homepage	S1 status, S2 status, Generator start status, switch status; Supply system diagram, QS1 is S1 power side switch, QS2 is S2 power side switch; S1/S2 voltage and frequency; S1/S2 priority set; Auto Trans./Restore status.
S1 Power S2 Power	S1 line voltage, phase voltage, phase sequence, frequency; S2 line voltage, phase voltage, phase sequence, frequency.
Time 	S1 accumulated power supply time; S2 accumulated power supply time; Current continuous power supply time; Last continuous power supply time; Accumulated auto running time.
QF 	QS1 accumulated close times; QS2 accumulated close times; Accumulated auto transfer times; Mains failure transfer times.
Synchronization 	Voltage difference; Frequency difference; Phase difference.
Comm. 	RS485-1 comm. status and baud rate, data bits, parity bit, stop bit; RS485-2 comm. status and baud rate, data bits, parity bit, stop bit; USB comm. status.
Alarms 	Current alarm information (warn alarm and fault alarm).
I/O 	Programmable digital input status and auxiliary status; Programmable digital output status.
Status	Alarm status/working status; Real-time clock; Statusline is showed below in every main screen pages.

**6.2 STATUS DESCRIPTION**

**Table 7 – S1 Voltage Status**

No.	Item	Description
1	S1 Available	S1 Normal Delay.
2	S1 Unavailable	S1 Abnormal Delay.
3	S1 Volt. Available	Power supply voltage is within the setting range.
4	S1 Blackout	Voltage is 0.
5	S1 Over Volt.	Voltage is higher than the set value.
6	S1 Under Volt.	Voltage is lower than the set value.
7	S1 Over Freq.	Frequency is higher than the set value.
8	S1 Under Freq.	Frequency is lower than the set value.
9	S1 Loss of Phase	Loss of 1-phase or 2-phase of A, B and C.
10	S1 Reverse Phase Seq.	A-B-C phase sequence is wrong.
11	S1 Instant. Under Volt.	Voltage is lower than the set value.

**Table 8 – S2 Voltage Status**

No.	Item	Description
1	S2 Available	S2 Normal Delay.
2	S2 Unavailable	S2 Abnormal Delay.
3	S2 Volt. Available	Power supply voltage is within the setting range.
4	S2 Blackout	Voltage is 0.
5	S2 Over Volt.	Voltage is higher than the set value.
6	S2 Under Volt.	Voltage is lower than the set value.
7	S2 Over Freq.	Frequency is higher than the set value.
8	S2 Under Freq.	Frequency is lower than the set value.
9	S2 Loss of Phase	Loss of 1-phase or 2-phase of A, B and C.
10	S2 Reverse Phase Seq.	A-B-C phase sequence is wrong.
11	S2 Instant. Under Volt.	Voltage is lower than the set value.

**Table 9 – Genset Status**

No.	Item	Description
1	Start Delay	Delay time before genset start.
2	Stop Delay	Delay time before genset stop.
3	Scheduled Not Run	When scheduled not run is active, its duration time will be displayed.
4	Scheduled Run	When scheduled run is active, its duration time will be displayed.
5	S1 Cycle Run	S1 cycle run countdown will begin when cycle start is active.
6	S2 Cycle Run	S2 cycle run countdown will begin when cycle start is active.
7	S1 Genset Working	Active only when system has 2 gensets and S1 is generating.
8	S2 Genset Working	Active only when system has 2 gensets and S2 is generating.
9	Genset Working	Genset start signal output.
10	Genset Standby	There is no genset start signal output.

**Table 10 – Switch Status**

No.	Item	Description
1	Ready to Transfer	Switch transfer begins.
2	QS1 Closing	QS1 closing delay is in progress.
3	QS2 Closing	QS2 closing delay is in progress.
4	Closing QS1 Again	If “Closing Again Delay” is not 0, when the QS1 “Fail to Open” condition occurs, it’s the delay time before the close relay is active for the second time.
5	Closing QS2 Again	If “Closing Again Delay” is not 0, when the QS2 “Fail to Open” condition occurs, it’s the delay time before the close relay is active for the second time.
6	Elevator Delay	Delay time before ATS transfer, elevator control outputs.
7	S1 On-load	QS1 was already closed and S1 is taking load.
8	S2 On-load	QS2 was already closed and S1 is taking load.
9	Off-load	Load is disconnected.

Warning alarms are active when controller detects the alarm signals, and alarm indicator will flash slowly (1 time per sec). When alarm is reset, indicator is extinguished, which means warning alarms are not latched.

**Table 11 – Warning Alarms**

No.	Item	Description
1	Battery Under Volt.	When the battery voltage has fallen below the pre-set value, it will initiate a warning alarm after 60s delay.
2	Battery Over Volt.	When the battery voltage has exceeded the pre-set value, it will initiate a warning alarm after 60s delay.

Fault alarms are active when controller detects the alarm signals. Alarm indicator will flash rapidly (5 times per sec) and the alarm will last until it was removed manually. Fault alarms are latched.

**Table 12 – Fault Aalrms**

No.	Item	Description
1	QS1 Failed to Close	QS1 fails to close.
2	QS2 Failed to Close	QS2 fails to close.
3	S1 Genset Fault	Only when system has 2 gensets and S1 is generating, S1 fails to start.
4	S2 Genset Fault	Only when system has 2 gensets and S2 is generating, S2 fails to start.
5	Sync. Failure Fault	Set sync. failure action as fault, when the sync. waiting has exceeded the pre-set value, it will initiate a fault alarm.

The indication information will continuously display for 2s after it is active.

**Table 13 – Indication Information**

No.	Item	Description
1	Please Reset the Alarm	When there is fault alarm occurs and alarm is not removed, the indication will be displayed when manually transfers to Auto Mode.
2	Panel Locked	The information displays when panel lock is active and keys are pressed (Manual, Auto, S1 Close, S2 Close, Auto Trans. Auto Restore/Non-restore, Alarm Mute and Alarm Reset keys).
3	Power Abnormal Transfer Inactive	Set "Power abnormal manual transfer" as "Disable", when S1 or S2 is manually closed, the indication will be displayed if the A phase voltage is abnormal.

**Table 14 – Other Status Information**

No.	Item	Description
1	Start Inhibit	Genset start Inhibit is active.
2	S1 Load Inhibit	S1 Load Inhibit input is active.
3	S2 Load Inhibit	S2 Load Inhibit input is active.
4	Remote Start On-load	Remote start (on load) signal is active.
5	Remote Start Off-load	Remote start (off load)signal is active.
6	Gen Start Mains NG	Start genset when mains is abnormal.
7	Cycle Run Mode	Active when S1 and S2 are both generating.
8	Balanced Run Mode	Active when S1 and S2 are both generating.
9	Master-Slave Run Mode	Active when S1 and S2 are both generating.
10	Auto Mode	Current mode is Auto mode.



No.	Item	Description
11	Manual Mode	Current mode is Manual mode.

### 6.3 MAIN MENU

In main screen, press  key will enter into the menu interface.

<ul style="list-style-type: none"> <li>1. Configuration</li> <li>2. Data Calibration</li> <li>3. Event Log</li> <li>4. Black Box Records</li> <li>5. Auto Trans. Auto Restore</li> <li>6. Genset Start/Stop</li> <li>7. Language</li> <li>8. About</li> </ul>	<p>Press <b>Up/Down</b> key to choose parameters (the current line was highlighted with black) and then press <b>Confirm</b> key to enter into the corresponding display screen.</p>
---	--

**NOTE1:** Default password is 01234, user can change it in case of others change the parameters setting. Please clearly remember the password after changing. If you forget it, please contact SmartGen services.

**NOTE2:** Data Calibration is for factory use only and correct passwords must be input before entered.

**7 START/STOP OPERATION**

**7.1 MANUAL START/STOP**

**7.1.1 PANEL START/STOP**

In the main screen, select “6. Genset Start/Stop” interface when system type is “S1 Mains S2 Gen, S1 Gen S2 Mains, S1 Mains S2 Mains”, then enter manual start operation interface.

Return Genset Stop Genset Start	Press “Up/Down” key to choose parameters (the current line was highlighted with black) and then press “Confirm” key to confirm.
---------------------------------------	---

**Genset Stop:** Disconnect the start signal, i.e. stop the running genset.

**Genset Start:** Output the start signal, i.e. start the genset.

When system type is “S1 Gen S2 Gen”, manual start/stop menu interface is as follows:

Return S1 Genset Stop S1 Genset Start S2 Genset Stop S2 Genset Start	Press “Up/Down” key to choose parameters (the current line was highlighted with black) and then press “Confirm” key to confirm.
--	---

**S1 Genset Stop:** Disconnect the S1 start signal, i.e. stop the running S1 genset.

**S1 Genset Start:** Output the S1 start signal, i.e. start the S1 genset.

**S2 Genset Stop:** Disconnect the S2 start signal, i.e. stop the running S2 genset.

**S2 Genset Start:** Output the S2 start signal, i.e. start the S2 genset.

**7.1.2 REMOTE COMMUNICATION START/STOP**

Send remote start/stop signals using MODBUS protocol via RS485 port.

**Remote Communication Stop:** Disconnect the start signal, i.e. stop the running genset.

**Remote Communication Start:** Output the start signal, i.e. start the genset.

## 7.2 AUTO START/STOP

### 7.2.1 START CONDITIONS

#### 7.2.1.1 INPUT START

Set input port as “Remote Start On Load” or “Remote Start Off Load”, both could not be set simultaneously.

**Remote Start on Load:** When the input is active, genset close relay will active after genset is normal; when the input inactive, genset will stop automatically.

**Remote Start off Load:** When the input is active, mains close relay will active after mains is normal; when the input inactive, genset will stop automatically.

#### 7.2.1.2 GEN START MAINS NG

When mains is abnormal, genset start outputs, gen close relay will active after gen is normal.

### 7.2.2 TWO GENSETS START/STOP

When system is “S1 Gen S2 Gen”, input port setting is as follows:

Set input port as “Remote Start On Load” or “Remote Start Off Load”, both could not be set simultaneously.

**Remote Start on Load:** Detect S1 or S2 start output according to start mode. Gen close relay will active after gen is normal.

**Remote Start off Load:** Detect S1 or S2 start output according to start mode. Both genset S1 close relay and S2 close relay are deactivated after genset start.

**Start Mode:** Cycle Run, Master-Slave Run, Balanced Run, None.

#### **Cycle Run**

When remote start is active, S1 and S2 cycle run start will according to the cycle run time. When firstly start the genset, choose “S1 Start” or “S2 Start” depends on “Priority”. e.g. S1 start firstly if “S1” has higher priority. Then S1 cycle run countdown is started according to the preset delay. At the same time, genset fault delay will be initiated. If S1 genset is normal before the fault delay has expired, S1 will take load; S2 start after the preset S1 cycle run delay has expired and the S2 loading process is same as S1. S1 will stop automatically after the S2 takes load successfully. S1 and S2 will cycle run in this way alternately until the remote start signal deactivated.

During the start process, if there is genset fault alarm (genset fault delay overtime or genset fault input is active), fail to close or load inhibit alarm occurs, the starting genset will stop immediately and the additional genset will start automatically.

During the cycle run process, if “Manual Mode” is selected, the current status will be hold and the “cycle run countdown” will be suspended.

#### **Master-Slave Run**

Master genset will start when remote start signal is active. During the start process, if there is genset fault alarm (genset supply delay overtime or genset fault input is active), fail to close or load

inhibit alarm occurs, the starting genset will stop immediately and the additional genset will start automatically. Otherwise, the master genset will run continuously until the remote start signal deactivated.

**Balanced Run**

The genset which has the shortest running hours will start when remote start signal is active. During the start process, if there is genset fault alarm (genset supply delay overtime or genset fault input is active), fail to close or load inhibit alarm occurs, the starting genset will stop immediately and the additional genset will start automatically. Otherwise, the current genset will run continuously until the remote start signal deactivated.

In system of “S1 Gen S2 gen” to start/stop genset should meet following several conditions:

- 1) It is active in Auto mode;
- 2) System type set as “S1 Gen S2 Gen”;
- 3) Output should be set as “S1 Genset Start” and “S2 Genset Start”;
- 4) Input should be set as “S1 Genset Fault Input”, “S2 Genset Fault Input” and “Remote Start On Load” or “Remote Start Off Load”;
- 5) Should set the system as “Two Gensets Start Mode”;
- 6) Should configure set “Genset Supply Delay”, If start mode is cycle run, also should set “S1 Cyps Run Time”, “S2 Cyps Run Time”.

Among input ports, “S1 Genset Fault Input”, “S2 Genset Fault Input” are selective setting, genset fault can be judged by “Genset Supply Delay” and there no need to inquire the fault alarm via input port.

When two gensets start mode configured as “None”, there is no genset start signals output.

For example:

**Table 15 – Genset Start**

System Type	Start Conditions	Result
S1 Gen S2 Gen	Input Active (Remote Start On Load/Remote Start Off Load)	S1 Genset Start Output
	Priority: S1	

**7.2.3 SCHEDULED RUN**

Once “Scheduled Run” enables, users can set the scheduled start time. Controller will send start signal at preset start time. Start signal will be deactivated after the start delay has expired. “Scheduled Run On Load” or “Scheduled Run Off Load” can be set.

**Scheduled Run On Load:** When the input is active, genset close relay will active after genset is normal.

**Scheduled Run Off Load:** When the input is active, mains close relay will active after mains is normal.

Cycle time of Scheduled Run can be set as start monthly, weekly and daily.

**Run Monthly:** Which month to start, start date and time can be set.

**Run Weekly:** Can start the genset at the same time in couple days of a week. Eg. Start the genset at 8:00 a.m. from Monday to Friday and keep 10 hours.

**Run Daily:** Can start the genset at same time everyday.

## 7.2.4 SCHEDULED NOT RUN

Once “Scheduled Not Run” enables, users can set the “Scheduled Not Start” time. Start signal will be deactivated at preset time and it will be inhibited before the delay has expired.

Cycle time of “Scheduled Not Run” can be set as monthly, weekly and daily.

**Not Run Monthly:** Which month not start, not start date and time can be set.

**Not Run Weekly:** Can not start the genset at the same time in couple days of a week. Eg. Not Start the genset at 19:00 p.m. from Monday to Friday and keep 12 hours.



**Not Run Daily:** Can not start the genset at same time everyday.

**▲NOTE3:** “Scheduled Not Run” operation is prior to “Scheduled Run” operation.

SmartGen

## 8 PARAMETERS CONFIGURATION

### 8.1 ILLUSTRATION

In the main interface, press /OK key, choose **Configuration** and press /OK again to enter into password confirmation interface. If password is correct, enter into parameter setting interface, otherwise, exit to main interface directly. Factory default password is **01234**. In parameters configuration interface, pressing  key to return the previous menu.

### 8.2 PARAMETERS CONFIGURATION

**Table 16 – Parameters Configuration**

No.	Item	Range	Default	Description
<b>AC Setting</b>				
1	S1 Volt Normal	(0-3600)s	10	The delay from S1 voltage abnormal to normal.
2	S1 Volt Abnormal	(0-3600)s	5	The delay from S1 voltage normal to abnormal.
3	S2 Volt Normal	(0-3600)s	10	The delay from S2 voltage abnormal to normal.
4	S2 Volt Abnormal	(0-3600)s	5	The delay from S2 voltage normal to abnormal.
5	Master Set	(0~1)	0	0: S1    1: S2
6	System Type	(0~3)	6	0: S1 Mains S2 Gen; 1: S1 Gen S2 Mains; 2: S1 Mains S2 Mains; 3: S1 Gen S2 Gen.
7	AC System	(0~3)	0	0: 3 Phase 4 Wire (3P4W) 1: 3 Phase 3 Wire (3P3W) 2: 2 Phase 3 Wire (2P3W) 3: Single Phase 2 Wire (1P2W)
8	PT Fitted	(0~1)	0	0: Disable    1: Enable
9	PT Primary Volt	(30~30000)V	100	Primary voltage of voltage transformer ratio.
10	PT Secondary Volt	(30~1000)V	100	Secondary voltage of voltage transformer ratio.
11	Rated Voltage	(0~30000)V	220	Rated voltage of AC system.
12	Over Volt Warn	(0~1)	1	0: Disable    1: Enable

No.	Item	Range	Default	Description
13	Set Value	(0~200)%	120	Upper limit value of voltage; it is abnormal if the value has exceeded the set value.
14	Return Value	(0~200)%	115	Upper limit return value of voltage; it is normal only when the value has fallen below the set value.
15	Under voltage Warn	(0~1)	1	0: Disable    1: Enable
16	Set Value	(0~200)%	80	Lower limit value of voltage; it is abnormal if the value has fallen below the set value.
17	Return Value	(0~200)%	85	Lower limit return value of voltage; it is normal only when the value has exceeded the set value.
18	Rated Frequency	(10.0~75.0)Hz	50.0	Rated frequency of AC system.
19	Over Frequency Warn	(0~1)	1	0: Disable    1: Enable
20	Set Value	(0~200)%	110	Upper limit value of frequency; it is abnormal if the value has exceeded the set value.
21	Return Value	(0~200)%	104	Upper limit return value of frequency; it is normal only when the value has fallen below the set value.
22	Under Frequency Warn	(0~1)	1	0: Disable    1: Enable
23	Set Value	(0~200)%	90	Lower limit value of frequency; it is abnormal if the value has fallen below the set value.
24	Return Value	(0~200)%	96	Lower limit return value of frequency; it is normal only when the value has exceeded the set value.
25	Reverse Phase Seq.	(0~1)	1	0: Disable    1: Enable
26	Instant. Under Volt	(0~1)	1	0: Disable    1: Enable
27	Set Value	(0~100)%	20	The power supply is judged to be off when the instantaneous under voltage is less than this value. The quick switch function is enabled in Auto Mode.

No.	Item	Range	Default	Description
<b>Switch Setting</b>				
1	Fixed Close Time	(0~1)	0	0: Disable 1: Enable Disable: The output time is depended on the close status; the longest output time is the set close time. Enable: The output time lasts for the preset time.
2	Close Delay	(0.1~20.0)s	5.0	Pulse time of close relay.
3	Auto Transfer/Restore	(0~1)	1	0: Auto Transfer Non-restore; 1: Auto Transfer/Restore.
4	Again Close Delay	(0~20.0)s	0.0	When the breaker fails to close for the first time, then the module will close for the second time and the Again Close Delay begins, after the delay has expired, if it still fails to close for the second time, the module will send out fail to close alarm.
5	Continually Close	(0~1)	0	0: Disable 1: Enable When switch close control is continuous, it needs to be enabled, "Close Time" and "Open Time" are deactivated.
6	Load Switch Transfer Interval	(0~9999)s	1	Delay time when each load is successively closed.
7	Load Switch Close Time	(0~20.0)s	5.0	Close relay pulse time when each load is successively closed, close relay continuously outputs when it is 0.
8	Power Supply Type	(0~1)	1	0: DC 1: AC
9	AC Volt Lower Limit	(0~100)%	70	Min. AC supply voltage. If it is lower than this value, switch transfer is inactive.
10	AC Volt Upper Limit	(0~200)%	200	Max. AC supply voltage. If it is higher than this value, switch transfer is inactive.
11	Power Abnormal Transfer Mode	(0~1)	1	0: Forced Transfer 1: Sync. Transfer When loading power has over/under voltage, over/under frequency, loss of phase, reverse phase sequence, another



No.	Item	Range	Default	Description
				power will be used. If "Sync. Transfer" is selected, it is active in over/under voltage, inactive in over/under frequency, reverse phase sequence. If "Forced Transfer" is selected, it is active when loading power is abnormal.
12	Manual Transfer	(0~1)	0	0: Disable 1: Enable If "Enable" is selected, when S1 or S2 is closed manually, if A phase voltage of this power is abnormal, transfer is deactivated. If "Disable" is selected, transfer is inactive.
<b>Sync. Setting</b>				
1	Sync. Transfer Enable	(0~1)	1	0: Disable 1: Enable
2	Sync. Voltage Difference Enable	(0~1)	0	0: Disable 1: Enable
3	Sync. Voltage Difference	(0~50)V	10	The max. voltage difference when synchronization success.
4	Sync. Frequency Difference	(0~3.00)Hz	3.00	The max. frequency difference when synchronization success.
5	Sync. Phase Difference	(0~20)°	5	The max. phase difference when synchronization success.
6	Sync. Failure Alarm Action	(0~1)	0	0: Warning Alarm 1: Fault Alarm After sync. failure, it continues to wait for synchronization until the switch is closed. When warning alarm occurs, the alarm will be cleared when synchronization is finished or exited. When fault alarm occurs, press alarm reset key to clear the alarm.
7	Sync. Failure Delay	(0~9999)s	120	Time to wait for sync. success, sync. failure when it exceeds the pre-set value.

No.	Item	Range	Default	Description
<b>Generator Setting</b>				
1	Start Delay	(0-9999)s	1	When the genset is ready to start, start delay begins, after the delay has expired, start signal will be initiated.
2	Stop Delay	(0-9999)s	5	When the genset is ready to stop, stop delay begins, after the delay has expired, start signal will be disconnected.
3	Two Gensets Start Mode	(0~3)	0	0: Cycle Run; 1: Master-Slave Run; 2: Balanced Run; 3: None.
4	S1 Cycle Run Time	(0~9999)min	720	Gens cycle start S1 running time.
5	S2 Cycle Run Time	(0~9999)min	720	Gens cycle start S2 running time.
6	Supply Delay	(0~9999)s	120	When the start signal is active, the start delay will be initiated. If the gen voltage lasts abnormal after the delay has expired, genset fault alarm will be initiated.
7	Battery Volt Detect	(0~1)	0	0: Disable ; 1: Enable
8	Battery Under Volt Warn	(0~1)	0	0: Disable ; 1: Enable
9	Set Value	(0~100.0)V	10.0	"Battery Under Volt" alarm will be initiated if the battery voltage has fallen below the set value.
10	Return Value	(0~100.0)V	10.5	"Battery Under Volt" alarm will be removed if the battery voltage has exceeded the set value.
11	Battery Over Volt Warn	(0~1)	0	0: Disable ; 1: Enable
12	Set Value	(0~100.0)V	30.0	"Battery Over Volt" alarm will be initiated if the battery voltage has exceeded the set value.
13	Return Value	(0~100.0)V	29.5	"Battery Over Volt" alarm will be removed if the battery voltage has fallen below the set value.
<b>Scheduled Run/Not Run Setting</b>				

No.	Item	Range	Default	Description
1	Schedule Run	(0~1)	0	0: Disable ; 1: Enable
2	Run Mode	(0~1)	0	0: Off Load; 1: On Load.
3	Cycle Selection	(0~2)	0	0: Monthly; 1: Weekly; 2: Daily.
4	Time (Month)	(1~4095)	4095	Bit0: Jan. Bit1: Feb. Bit2: Mar. Bit3: Apr. Bit4: May Bit5: June Bit6: July Bit7: Aug. Bit8: Sep. Bit9: Oct. Bit10: Nov. Bit11: Dec.
5	Time (Date)	(1~31)	1	The date of start the genset.
6	Time (Week)	(1~127)	1	Bit0: Sunday Bit1: Monday Bit2: Tuesday Bit3: Wednesday Bit4: Thursday Bit5: Friday Bit6: Saturday
7	Time (Hour)	(0~23)h	0	The time of genset start.
8	Time (Minute)	(0~59)min	0	
9	Duration	(0~30000)min	30	The duration time of genset running.
10	Scheduled Not Run	(0~1)	0	0: Disable 1: Enable
11	Cycle Selection	(0~2)	0	0: Monthly; 1: Weekly; 2: Daily.
12	Time (Month)	(1~4095)	4095	Bit0: Jan. Bit1: Feb. Bit2: Mar.

No.	Item	Range	Default	Description
				Bit3: Apr. Bit4: May Bit5: June Bit6: July Bit7: Aug. Bit8: Sep. Bit9: Oct. Bit10: Nov. Bit11: Dec.
13	Time (Date)	(1~31)	1	The date of genset not start.
14	Time (Week)	(1~127)	1	Bit0: Sunday Bit1: Monday Bit2: Tuesday Bit3: Wednesday Bit4: Thursday Bit5: Friday Bit6: Saturday
15	Time (Hour)	(0~23)	0	The time of genset not start.
16	Time (Minute)	(0~59)	0	
17	Duration	(0~30000)	30	The duration time of genset <i>NOT</i> running.
<b>Load Setting</b>				
1	Elevator Enable	(0~1)	0	0: Disable    1: Enable
2	Elevator Delay	(0~300)s	300	It's the delay time before the load disconnect or switch transfer. Used for control the running elevator stop at the nearest floor until the switch transfer is terminated.
<b>Digit Inputs Setting</b>				
1	Digital Input 1	(0~35)	0	Not Used.
2	Active Type	(0~1)	0	0: Close to activate; 1: Open to activate.
3	Digital Input 2	(0~35)	0	Not Used.
4	Active Type	(0~1)	0	0: Close to activate; 1: Open to activate.
5	Digital Input 3	(0~35)	0	Not Used.

No.	Item	Range	Default	Description
6	Active Type	(0~1)	0	0: Close to activate; 1: Open to activate.
7	Digital Input 4	(0~35)	0	Not Used.
8	Active Type	(0~1)	0	0: Close to activate; 1: Open to activate.
9	Digital Input 5	(0~35)	0	Not Used.
10	Active Type	(0~1)	0	0: Close to activate; 1: Open to activate.
11	Digital Input 6	(0~35)	0	Not Used.
12	Active Type	(0~1)	0	0: Close to activate; 1: Open to activate.
13	Digital Input 7	(0~35)	0	Not Used.
14	Active Type	(0~1)	0	0: Close to activate; 1: Open to activate.
15	Digital Input 8	(0~35)	0	Not Used.
16	Active Type	(0~1)	0	0: Close to activate; 1: Open to activate.
<b>Relay Outputs Setting</b>				
1	Relay Output 1 Active Type	(0~1)	0	0: Output (NO) 1: Output (NC)
2	Contents Setting	(0~99)	0	Not Used.
3	Relay Output 2 Active Type	(0~1)	0	0: Output (NO) 1: Output (NC)
4	Contents Setting	(0~99)	0	Not Used.
5	Relay Output 3 Active Type	(0~1)	0	0: Output (NO) 1: Output (NC)
6	Contents Setting	(0~99)	0	Not Used.
7	Relay Output 4 Active Type	(0~1)	0	0: Output (NO) 1: Output (NC)
8	Contents Setting	(0~99)	0	Not Used.
9	Relay Output 5 Active Type	(0~1)	0	0: Output (NO) 1: Output (NC)
10	Contents Setting	(0~99)	0	Not Used.
11	Relay Output 6 Active Type	(0~1)	0	0: Output (NO) 1: Output (NC)
12	Contents Setting	(0~99)	0	Not Used.

No.	Item	Range	Default	Description
13	Relay Output 7 Active Type	(0~1)	0	0: Output (NO) 1: Output (NC)
14	Contents Setting	(0~99)	0	Not Used.
15	Relay Output 8 Active Type	(0~1)	0	0: Output (NO) 1: Output (NC)
16	Contents Setting	(0~99)	0	Not Used.
17	Relay Output 9 Active Type	(0~1)	1	0: Output (NO) 1: Output (NC)
18	Contents Setting	(0~99)	32	Genset Start.
19	Relay Output 10 Active Type	(0~1)	0	0: Output (NO) 1: Output (NC)
20	Contents Setting	(0~99)	0	Not Used.
21	Combined 1 or Out 1 Active Type	(0~1)	0	0: Output (NO) 1: Output (NC)
22	Combined 1 or Out 1 Contents Setting	(0~99)	23	S1 Available
23	Combined 1 or Out 2 Active Type	(0~1)	0	0: Output (NO) 1: Output (NC)
24	Combined 1 or Out 2 Contents Setting	(0~99)	25	S2 Available
25	Combined 1 and Out Active Type	(0~1)	1	0: Output (NO) 1: Output (NC)
26	Combined 1 and Out Contents Setting	(0~99)	0	Not Used.
27	Combined 2 or Out 1 Active Type	(0~1)	0	0: Output (NO) 1: Output (NC)
28	Combined 2 or Out 1 Contents Setting	(0~99)	0	Not Used.
29	Combined 2 or Out 2 Active Type	(0~1)	0	0: Output (NO) 1: Output (NC)
30	Combined 2 or Out 2 Contents Setting	(0~99)	0	Not Used.
31	Combined 2 and Out Active Type	(0~1)	0	0: Output (NO) 1: Output (NC)
32	Combined 2 and Out Contents Setting	(0~99)	0	Not Used.

No.	Item	Range	Default	Description
33	Combined 3 or Out 1 Active Type	(0~1)	0	0: Output (NO) 1: Output (NC)
34	Combined 3 or Out 1 Contents Setting	(0~99)	0	Not Used.
35	Combined 3 or Out 2 Active Type	(0~1)	0	0: Output (NO) 1: Output (NC)
36	Combined 3 or Out 2 Contents Setting	(0~99)	0	Not Used.
37	Combined 3 and Out Active Type	(0~1)	0	0: Output (NO) 1: Output (NC)
38	Combined 3 and Out Contents Setting	(0~99)	0	Not Used.
39	Combined 4 or Out 1 Active Type	(0~1)	0	0: Output (NO) 1: Output (NC)
40	Combined 4 or Out 1 Contents Setting	(0~99)	0	Not Used.
41	Combined 4 or Out 2 Active Type	(0~1)	0	0: Output (NO) 1: Output (NC)
42	Combined 4 or Out 2 Contents Setting	(0~99)	0	Not Used.
43	Combined 4 and Out Active Type	(0~1)	0	0: Output (NO) 1: Output (NC)
44	Combined 4 and Out Contents Setting	(0~99)	0	Not Used.
45	Combined 5 or Out 1 Active Type	(0~1)	0	0: Output (NO) 1: Output (NC)
46	Combined 5 or Out 1 Contents Setting	(0~99)	0	Not Used.
47	Combined 5 or Out 2 Active Type	(0~1)	0	0: Output (NO) 1: Output (NC)
48	Combined 5 or Out 2 Contents Setting	(0~99)	0	Not Used.
49	Combined 5 and Out Active Type	(0~1)	0	0: Output (NO) 1: Output (NC)
50	Combined 5 and Out Contents Setting	(0~99)	0	Not Used.

No.	Item	Range	Default	Description
51	Combined 6 or Out 1 Active Type	(0~1)	0	0: Output (NO) 1: Output (NC)
52	Combined 6 or Out 1 Contents Setting	(0~99)	0	Not Used.
53	Combined 6 or Out 2 Active Type	(0~1)	0	0: Output (NO) 1: Output (NC)
54	Combined 6 or Out 2 Contents Setting	(0~99)	0	Not Used.
55	Combined 6 and Out Active Type	(0~1)	0	0: Output (NO) 1: Output (NC)
56	Combined 6 and Out Contents Setting	(0~99)	0	Not Used.
<b>Module Setting</b>				
1	Power On Mode	(0-2)	0	0: Last Mode (Keep the working mode last time running); 1: Manual Mode; 2: Auto Mode.
2	Language	(0~2)	0	0: Simplified Chinese; 1: English; 2: Other (Language can be set via PC software, Default: Traditional Chinese).
3	Password	(00000~65535)	01234	Password for entering parameters setting.
4	Module Address	(1~254)	1	RS485 communication address.
5	RS485-1 Baud Rate	(0~3)	2	0: 2400bps; 1: 4800bps; 2: 9600bps; 3: 19200bps.
6	RS485-1 Stop Bit	(1~2)	2	2 stop bits or 1 stop bit can be set.
7	RS485-1 Parity Bit	(0~2)	0	0: None; 1: Odd Parity; 2: Even Parity.
8	RS485-2 Baud Rate	(0~3)	2	0: 2400bps; 1: 4800bps; 2: 9600bps; 3: 19200bps.



No.	Item	Range	Default	Description
9	RS485-2 Stop Bit	(1~2)	2	2 stop bits or 1 stop bit can be set.
10	RS485-2 Parity Bit	(0~2)	0	0: None; 1: Odd Parity; 2: Even Parity.
11	RS485-1 Comm. Set	(0~3)	0	0: Remote Adjusting/Control Enable; 1: Remote Control Disable; 2: Remote Adjusting Disable; 3: Remote Adjusting/Control Disable.
12	RS485-2 Comm. Set	(0~3)	0	0: Remote Adjusting/Control Enable; 1: Remote Control Disable; 2: Remote Adjusting Disable; 3: Remote Adjusting/Control Disable.
13	Date and Time			
14	Controller Description 1	(0~20) characters		Information displayed in "About" interface.
15	Controller Description 2	(0~20) characters		Any characters can be inputted via PC software (letter occupies 1 character, Chinese character occupies 2.).

**8.3 DIGITAL INPUT/OUTPUT FUNCTION DESCRIPTION**

**8.3.1 INPUT PORTS FUNCTION DESCRIPTION**

**Table 17 – Input Ports Function Description**

No.	Item	Description
0	Not Used	Input port is invalid.
1	Reserved	
2	Remote Start On Load	Genset start output, when mains is normal, genset will close the breaker.
3	Remote Start Off Load	Genset start output, when mains is normal, mains will close the breaker.
4	Lamp Test	When active, all LED lights on the panel are illuminated and the backlight of the LCD is illuminated while the LCD screen is black.
5	Gen1 Fault Input	In Cycle start, if the input is active, S1 Gens start will be inhibited.
6	Gen2 Fault Input	In Cycle start, if the input is active, S2 Gens start will be inhibited.
7	Start Inhibit Input	In Auto mode, start signal will be deactivated after the stop delay has expired. In Manual mode, if the genset is running, users should stop it manually; then the manual start signal will be deactivated.
8	Reserved	
9	Reserved	
10	S1 Close Inhibit	In Manual mode, S1 manual close is inhibited; if breaker already closed, users should open it manually. In Auto mode, if breaker already closed, then close relay will deactivated or S2 takes load.
11	S2 Close Inhibit	In Manual mode, S2 manual close is inhibited; if breaker already closed, users should open it manually. In Auto mode, if breaker already closed, then close relay will deactivated or S1 takes load.
12	Reserved	
13	Reserved	
14	S1 Close Input	Same as S1 close key, the self-reset key is used to control S1 close.
15	S2 Close Input	Same as S2 close key, the self-reset key is used to control S2 close.
16	Reserved	
17	Alarm Reset	Reset the current alarm.
18	Alarm Mute	Silence the audible alarm.
19	Reserved	
20	Reserved	
21	S1 Master Input	Set S1 master use compulsively.
22	S2 Master Input	Set S2 master use compulsively.

No.	Item	Description
23	Forced Manual Mode	Set the controller in Manual mode compulsively.
24	Forced Auto Mode	Set the controller in Auto mode compulsively.
25	Panel Lock	Panel key operations are inhibited (Except Up, Down, Confirm, Return and Lamp Test keys).
26	Reserved	
27	Scheduled Start/Stop Inhibit	Schedule Start and Stop function are deactivated.
28	Simulate S1 OK	Simulate S1 voltage is normal; the S1 voltage abnormal delay is deactivated.
29	Simulate S2 OK	Simulate S2 voltage is normal; the S2 voltage abnormal delay is deactivated.
30	Auto Transfer/Restore Input	Auto trans. auto restore when active and auto trans. non-restore when inactive.
31	Reserved	
32	Reserved	
33	Remote Control Inhibit	Remote control operation is inactive when input is active.
34	Reserved	
35	Reserved	

### 8.3.2 OUTPUT PORTS FUNCTION DESCRIPTION

Table 18 – Output Ports Function Description

No.	Items	Description
0	Not Used	Output port is invalid.
1	Custom Combined 1	
2	Custom Combined 2	
3	Custom Combined 3	
4	Custom Combined 4	
5	Custom Combined 5	
6	Custom Combined 6	
7	Reserved	
8	Reserved	
9	Reserved	
10	Reserved	
11	Common Alarm	It includes fault alarm and warn alarm.
12	Common Fault Alarm	It includes "Transfer Failure" alarm.
13	Common Warn Alarm	It includes "Battery Over/Under Voltage" warning.

No.	Items	Description
14	Transfer Failure	It includes "QS1 Close failure" alarm, "QS1 Open Failure" alarm, "QS2 Close Failure" alarm, "QS2 Open Failure" alarm.
15	Audible Alarm	Action when common alarm occurs. Can be connected annunciator externally. When "alarm mute" input is active or 60s delay has expired, it can remove the alarm.
16	Reserved	
17	Genset Start Delay	Output when start signal is initiated.
18	Genset Stop Delay	Output when stop signal is initiated.
19	Elevator Control	Output before the load disconnect or switch transfer. Used for control the running elevator stop at the nearest floor until the switch transfer is terminated.
20	Reserved	
21	Reserved	
22	Reserved	
23	S1 Available	Output when S1 power is normal.
24	S1 Unavailable	Output when S1 power is abnormal.
25	S2 Available	Output when S2 power is normal.
26	S2 Unavailable	Output when S2 power is abnormal.
27	Reserved	
28	Reserved	
29	Reserved	
30	Auto Mode	Output when the genset is in Auto mode.
31	Manual Mode	Output when the genset is in Manual mode.
32	Genset Start	Control the genset to start.
33	Reserved	
34	QS1 Close Control	Control the QS1 switch to close.
35	Reserved	
36	QS2 Close Control	Control the QS2 switch to close.
37	Reserved	
38	Reserved	
39	Reserved	
40	Reserved	
41	Reserved	
42	Reserved	
43	Reserved	
44	Reserved	

No.	Items	Description
45	QS1 Closed Input	The close status of S1 switch.
46	QS2 Closed Input	The close status of S2 switch.
47	S1 Genset Start	When the system type is "S1 Gen S2 Gen", it controls the S1 genset start.
48	S2 Genset Start	When the system type is "S1 Gen S2 Gen", it controls the S2 genset start.
49	ATS Power L1	ATS power supply.
50	ATS Power L2	
51	ATS Power L3	
52	ATS Power N	
53	Remote Control	Control the output via RS485 communication command.
54	Input 1 Status	Aux. Input status.
55	Input 2 Status	
56	Input 3 Status	
57	Input 4 Status	
58	Input 5 Status	
59	Input 6 Status	
60	Input 7 Status	
61	Input 8 Status	
62	Reserved	
63	Reserved	
64	S1 Blackout	S1 power supply status.
65	S1 Over Volt	
66	S1 Under Volt	
67	S1 Over Freq	
68	S1 Under Freq	
69	S1 Loss of Phase	
70	S1 Reverse Phase Sequence	
71	Reserved	
72	Reserved	
73	S2 Blackout	S2 power supply status.
74	S2 Over Volt	
75	S2 Under Volt	
76	S2 Over Freq	
77	S2 Under Freq	
78	S2 Loss of Phase	

No.	Items	Description
79	S2 Reverse Phase Sequence	
80	Reserved	
81	Reserved	
82	Sync. Failure	
83	Waiting for Sync.	
84	Transferring	Output during the switch transfer process.
85	Battery Under Volt	Output when battery under voltage alarm occurs.
86	Battery Over Volt	Output when battery over voltage alarm occurs.
87	Scheduled Not Run	Output during the Scheduled Not Run process.
88	Scheduled Run	Output during the Scheduled Run process.
89	Reserved	
90	Reserved	
91	Load 1 Close Output	Output when Load 1 is active.
92	Load 2 Close Output	Output when Load 2 is active.
93	Load 3 Close Output	Output when Load 3 is active.
94	Load 4 Close Output	Output when Load 4 is active.
95	Load 5 Close Output	Output when Load 5 is active.
96	Load 6 Close Output	Output when Load 6 is active.
97	Load 7 Close Output	Output when Load 7 is active.
98	Load 8 Close Output	Output when Load 8 is active.
99	Reserved	

### 8.3.3 CUSTOM COMBINED OUTPUT

Defined combination output is composed by 3 parts, OR condition output SW1, OR condition output SW2, AND condition output SW3.

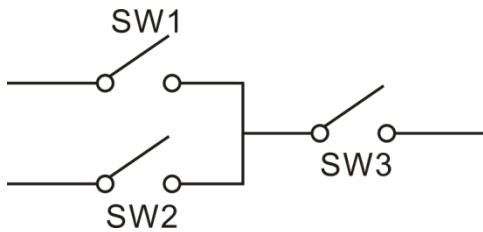

SW1 or SW2 is **TRUE**, and SW3 is **TRUE**, defined combination output is active;

SW1 and SW2 are **FALSE**, or SW3 is **FALSE**, defined combination output is deactivated.

**NOTE4:** SW1, SW2, SW3 can be set as any contents except for “defined combination output” in the output setting.

**NOTE5:** 3 parts of defined combination output (SW1, SW2, SW3) couldn’t include or recursively include themselves.

Example,

Contents of OR condition output SW1: input port 1 is active;

Active type of OR condition output SW1: normally open output (disconnect when inactive);

Contents of OR condition output SW2, input port 2 is active;

Active type of OR condition output SW2: normally open output (disconnect when inactive);



Contents of AND condition output SW3: input port 3 is active;

Active type of AND condition output SW3: normally open output (disconnect when inactive);

When input port 1 active or input port 2 active, if input port 3 is active, defined combination output is outputting; If input port 3 is inactive, defined combination output is not outputting;

When input port 1 inactive and input port 2 inactive, whatever input port 3 is active or not, defined combination output is not outputting.

## 9 EVENT LOG

On the main screen press  key and select **Event Log**, and then press  key again, the screen will show the event log interface.

Each event log includes:

- Log date and time
- Log type
- Event
- S1 power status
- S2 power status
- S1 3-phase voltage
- S2 3-phase voltage
- S1 frequency
- S2 frequency

Maximum pieces of event log are 200. The first record is latest, and users could check every records by up/down keys. The latest record will cover the oldest one when records amount exceeds 200.



Event log type includes: Action Event, Warn Event and Fault Event. Fault events are all fault alarms while warn events are all warn alarms.

**Table 19 – Action Events List**

No.	Action Events	Description
1	Closing QS1	Record when the QS1 close relay activated.
2	Closing QS2	Record when the QS2 close relay activated.
3	QS1 Sync. Closing	Record when the QS1 sync. close relay activated.
4	QS2 Sync. Closing	Record when the QS2 sync. close relay activated.
5	Genset Start	Record when the genset start signal outputs.
6	S1 Genset Start	Record when the S1 genset start signal output.
7	S2 Genset Start	Record when the S2 genset start signal output.
8	Genset Stop	Record when the genset start signal deactivated.
9	S1 Genset Stop	Record when the S1 genset start signal deactivated.
10	S2 Genset Stop	Record when the S2 genset start signal deactivated.
11	Auto Mode	Record when the genset transfers to Auto Mode.
12	Manual Mode	Record when the genset transfers to Manual Mode.
13	Manual S1 Close Key	Record when operate S1 close key of front panel.
14	Manual S2 Close Key	Record when operate S2 close key of front panel.
15	Remote S1 Close Key	
16	Remote S2 Close Key	



**10 BLACK BOX RECORDS**

On the main screen press  key and select **Black Box Records**, and then press  key again, the screen will show the black box records interface.

Each record includes:

- Record date and time
- Record type
- Event
- S1 power status
- S2 power status
- S1 3-phase voltage
- S2 3-phase voltage
- S1 frequency
- S2 frequency

Maximum pieces of black box record are 5. Every event records total 60s (before and after) data information of this event, and record once per second. The latest record will cover the oldest one when records amount exceeds 5. The first record is latest. Users could check details by pressing Confirm Key, and could check the 60 datas by up/down keys.

Record type: the action event of close/open switching in auto mode.

**Table 20 – Action Events List**

No.	Action Events	Description
1	Auto S1 Close	QS1 Close in auto mode.
2	Auto S2 Close	QS2 Close in auto mode.

## 11 SWITCH OPERATION

### 11.1 SYNCHRONOUS TRANSFER DESCRIPTION

Synchronous close refers to current loading power supply transfers to the other power supply with load, in the case of S1, S2 power are normal (meet the synchronous voltage difference, frequency difference, phase difference) or power supply abnormal (meet frequency difference, phase difference). Synchronous transfer is required in this process.

**Sync. Transfer Enable:** When it is enabled, sync. transfer function is active; otherwise, it is inactive.

**Sync. Volt. Difference (the average value difference of 2-way voltage):** Max. voltage difference of S1 and S2 when synchronization. If sync. voltage difference is disabled or one power is abnormal, no voltage difference detection during synchronization.

**Sync. Freq. Difference:** Max. frequency difference of S1 and S2 when synchronization.

**Sync. Phase Difference:** Max. phase difference of S1 and S2 when synchronization. Generally, it cannot be set too high, otherwise load impact is too large during transfer.

**Sync. Failure Alarm Action:** Can be set as warn alarm or fault alarm. It still waits for synchronization when failure until switch is closed. When warn alarm occurs, the alarm will be cleared when synchronization is finished or exited. When fault alarm occurs, press alarm reset key to clear the alarm.

**Sync. Failure Delay:** Synchronous waiting time. "Sync. Failure" alarm will be initiated when overtime.



**Power Abnormal Transfer Mode:** Can be set as sync. transfer or forced transfer. When "Sync. Transfer" is enabled, loading power will transfer in over/under voltage, loss of phase, not transfer in over/under frequency, reverse phase sequence. When "Forced Transfer" is enabled, ATS directly transfers to normal power side when loading power is abnormal without synchronous detection.

### 11.2 MANUAL OPERATION

Manual mode is selected by pressing the  key; a LED beside it will illuminate to confirm the operation.

ATS will start to transfer immediately after pressing the corresponding key. During the process, corresponding lamps will flash, and then the lamp will be normally illuminated when switch is done. Operation logic in manual mode is as below:

**Table 21 – Manual Transfer Keys**

Icon	Key Name	Description
	S1 Close Key	QS1 close and S1 supply after pressing this key; S1 close can be cancelled after pressing this key when S1 waits for synchronous closing.
	S2 Close Key	QS2 close and S2 supply after pressing this key; S2 close can be cancelled after pressing this key when S2 waits for synchronous closing.

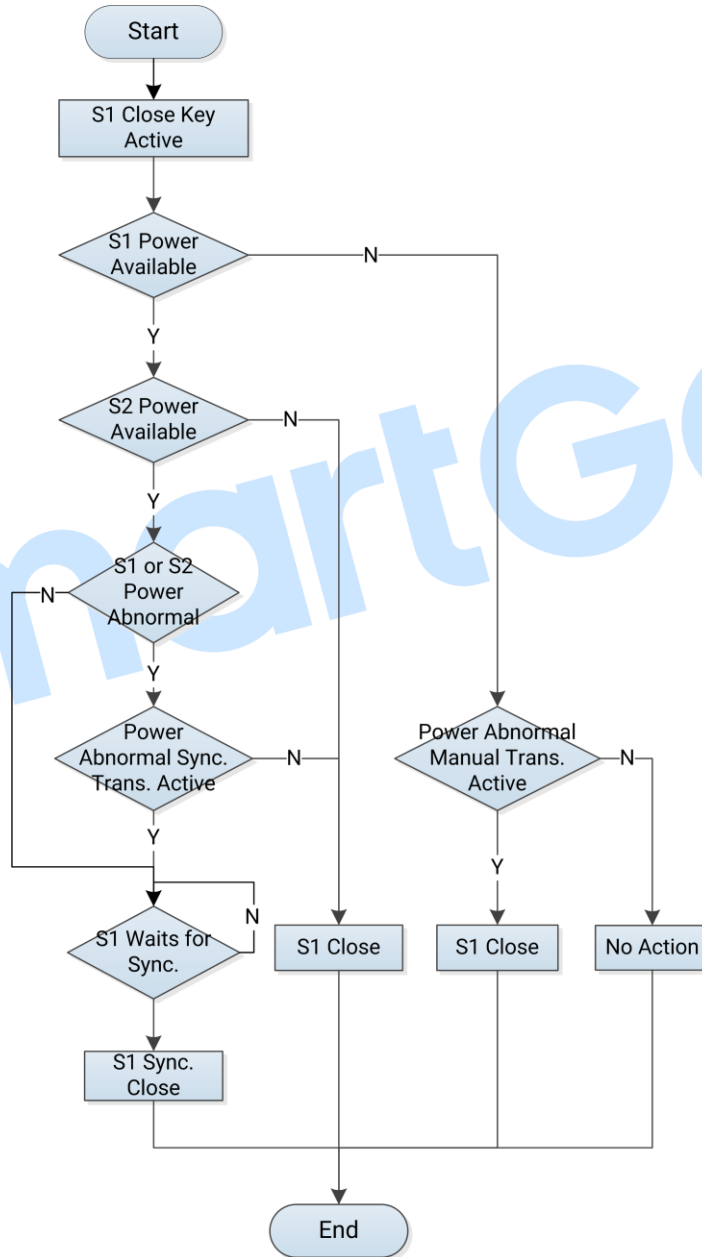

**Fig.2 – S1 Manual Close Flowchart**

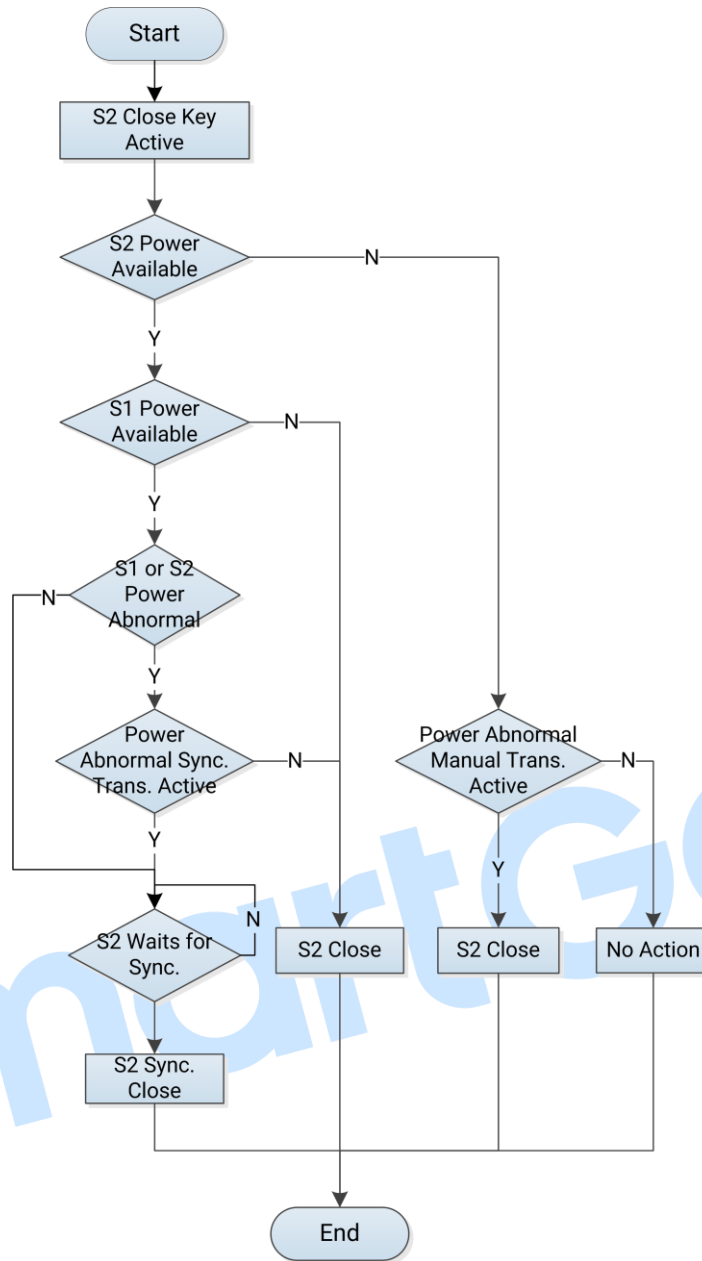

**Fig.3 – S2 Manual Close Flowchart**

**NOTE:** When “Power Abnormal Manual Trans.” is active, S1 or S2 is manually closed, if A phase voltage of this power is abnormal, ATS can transfer; When it is inactive, S1 or S2 is manually closed, if A phase voltage of this power is abnormal, ATS not transfer.

11.3 AUTOMATIC OPERATION

11.3.1 ILLUSTRATION

Auto mode is selected by pressing the  key; a LED beside it will illuminate to confirm the operation.

Under auto mode, the controller will transfer automatically to ensure power supply according to S1, S2 status, transfer priority and auto transfer/restore status.

**NOTE:** During the process, if close failure or close inhibit occurs, the corresponding switch will not execute close actions, and other closed switch will supply power.

11.3.2 AUTO TRANSFER AUTO RESTORE

When set as “Auto Transfer/Restore”, S1 master run, if S1 is normal, S1 will close; if S1 is abnormal, S2 is normal, S2 will close; if S1 returns normal, S1 will close.

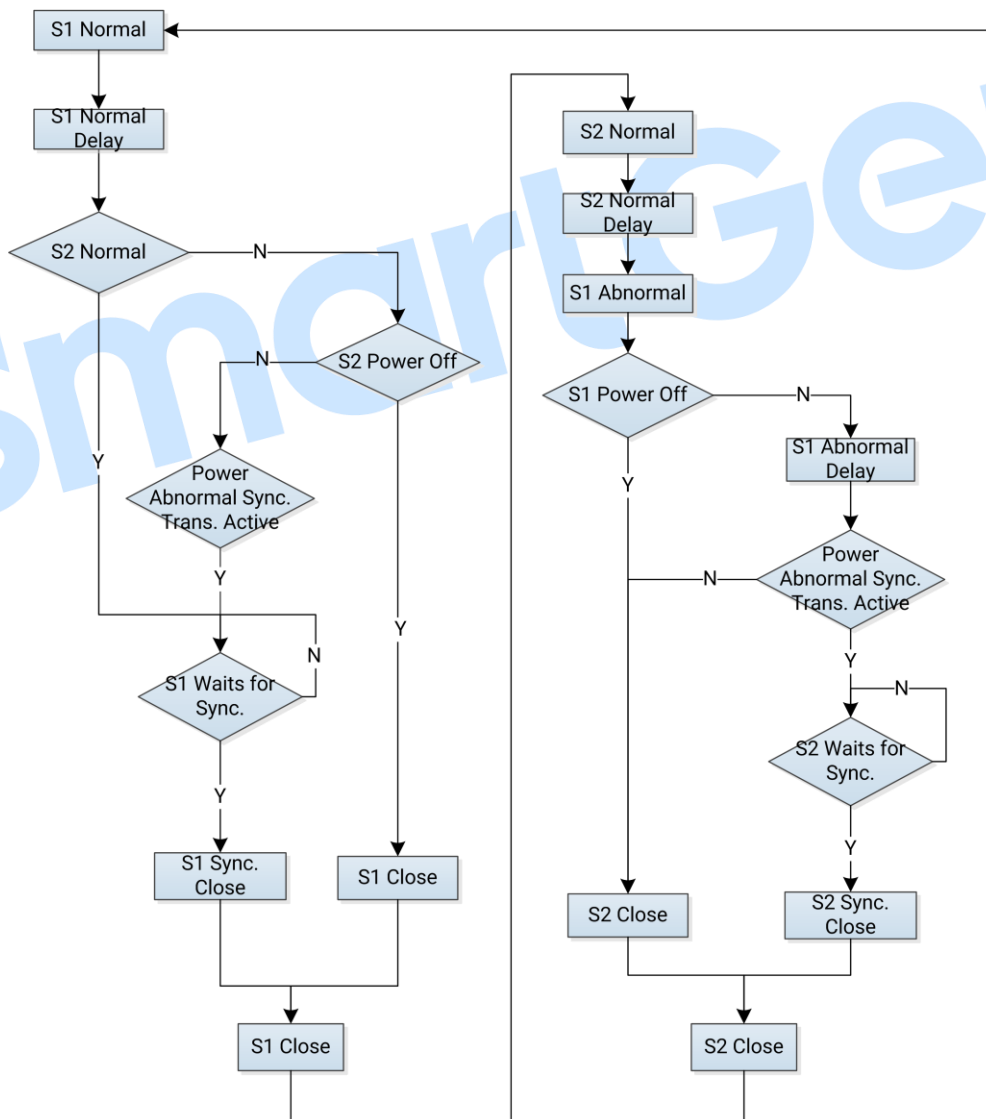

Fig.4 – Auto Transfer/Restore Flowchart

11.3.3 AUTO TRANSFER NON-RESTORE

When set as “Auto Transfer Non-restore”, S1 master run, if S1 is normal, S1 will close; if S1 is abnormal, S2 is normal, S2 will close; if S1 returns normal, S2 is normal, switch keeps in “S2 Close” status.

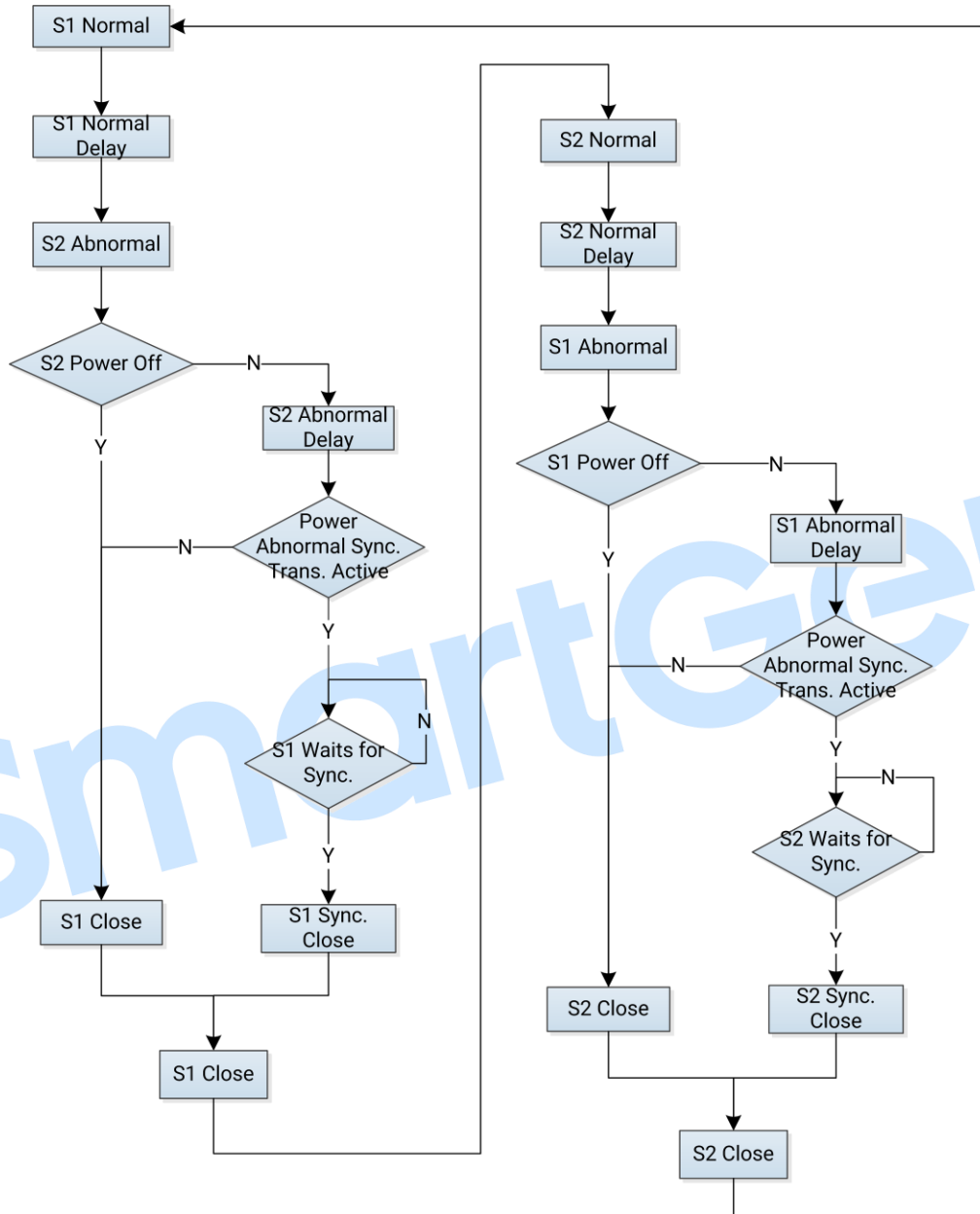
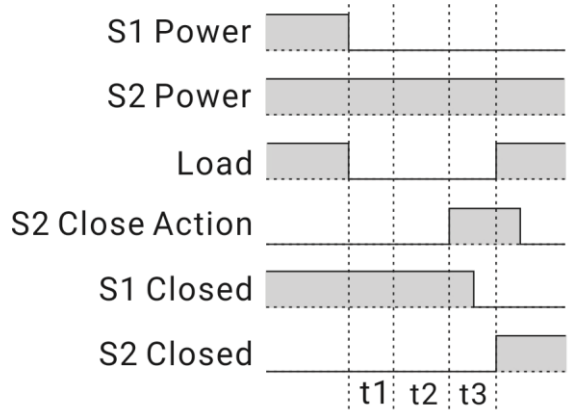

Fig.5 – Auto Transfer Non-restore Flowchart

12 LOAD OUTAGE TIME DESCRIPTION

Take S1 master, auto transfer/restore as example, transfer time of high speed switch should be less than 5ms.

- When S1 power outage, controller detects that after t1 time, after t2 time, S2 close output port works, high speed switch starts to work, after t3 time, S2 close is finished by the switch. Load outage time is less than 20ms, which is shown as below picture:



t1 : S1 outage detection time  
 t2 : S2 closed response time  
 t3 : Time of high speed switch executes action  
 Load outage time:  $t1+t2+t3 < 20ms$

**Fig.6 – Load Outage Time when Power Abnormal Transfer**

- When S1 returns normal, S1 takes load from S2, after t4 time, S1 normal is confirmed and synchronous detection is finished simultaneously, S1 close relay outputs. After t5 time, S1 close is finished by the switch. Load outage time is switch transfer time, which is shown as below picture:

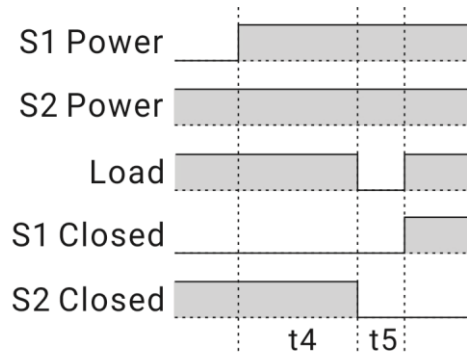

t4 : Time of S1 normal and S1 sync. close  
 t5 : High speed switch transfer time  
 Load outage time: t5

**Fig.7 – Load Outage Time when Power Normal Transfer**

**13 COMMUNICATION CONFIGURATION AND CONNECTION**

**13.1 ILLUSTRATION**

HAT828 ATS controller equips with RS485, USB communication ports. RS485 communication port enables the connection of open structure LAN. It uses Modbus protocol via PC or software operated on data acquisition system, which can provide the management plan of dual power ATS transfer for factories, telecom, industrial and civil buildings, and achieve “remote control, remote measuring, remote communication” functions.

More information of Communication Protocol, please refer to *HAT828 Communication Protocol*.

**13.2 RS485 COMMUNICATION**

HAT828 ATS controller has two isolated RS485 communication ports, one for RS485 LAN monitoring, the other for CMM366 series communication module connection to realize cloud monitoring.

Communication protocol: Modbus-RTU.

**Communication parameters:**

- Module address 1 (range: 1~254)
- Baud rate 9600bps (2400/4800/9600/19200bps)
- Data bit 8-bit
- Parity bit None (No parity, odd parity, even parity)
- Stop bit 2 bits (1-bit or 2-bit)

**13.3 USB COMMUNICATION**

There is a D-type USB port which can be used to connect PC for software upgrading and parameter setting.

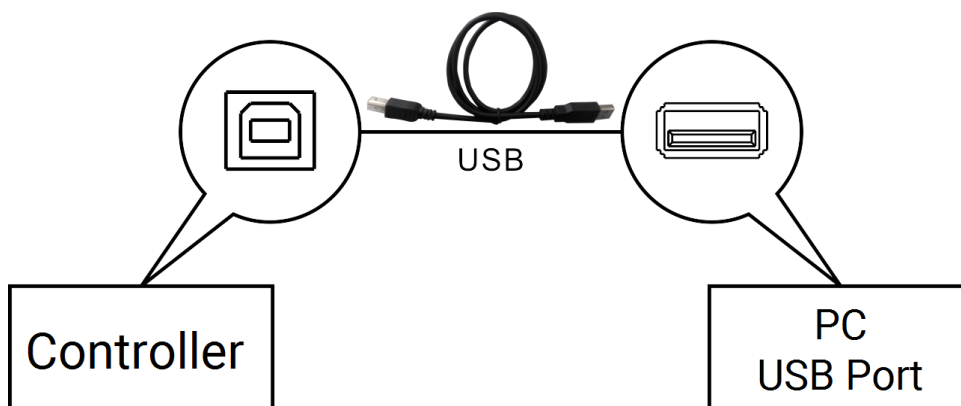
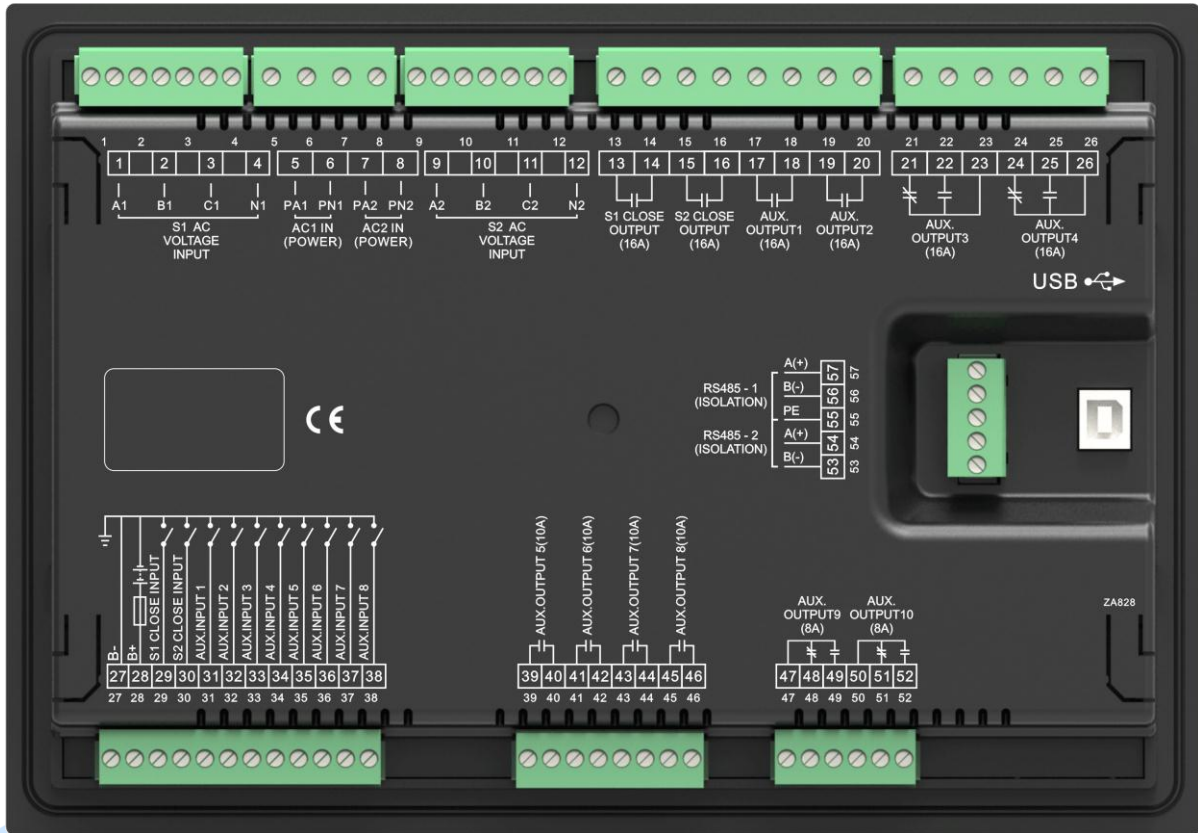

**Fig.8 – USB Connection Diagram**



**14 TERMINALS**

**14.1 TERMINAL DESCRIPTION**



**Fig.9 – Controller Rear Panel Drawing**

**Table 22 – Inputs/Outputs Function Description**

No.	Items	Description	Remark
1	A1	S1 AC 3P4W Voltage Input	For single phase, only connects A1, N1.
2	B1		
3	C1		
4	N1		
5	PA1	POWER1	Can be phase voltage or line voltage, supply range AC(90~576)V.
6	PN1	AC Supply	
7	PA2	POWER2	Can be phase voltage or line voltage, supply range AC(90~576)V.
8	PN2	AC Supply	
9	A2	S2 AC 3P4W Voltage Input	For single phase, only connectd A2, N2.
10	B2		
11	C2		
12	N2		
13	S1 CLOSE OUTPUT	S1 Close Output Port	Volts free relay; Normally open

No.	Items	Description	Remark
14			output. Capacity: 16A AC250V.
15	S2 CLOSE OUTPUT	S2 Close Output Port	Volts free relay; Normally open output. Capacity: 16A AC250V.
16			
17	AUX. OUTPUT1	Aux. Output Port 1	Default: Not Used. Volts free relay; Normally open output. Capacity: 16A AC250V.
18			
19	AUX. OUTPUT2	Aux. Output Port 2	Default: Not Used. Volts free relay; Normally open output. Capacity: 16A AC250V.
20			
21	AUX. OUTPUT3	N/C	Aux. Output Port 3 Default: Not Used. Volts free relay Normally open/close output. Capacity: 16A AC250V.
22		N/O	
23		COM	
24	AUX. OUTPUT4	N/C	Aux. Output Port 4 Default: Not Used. Volts free relay; Normally open/close output. Capacity: 16A AC250V.
25		N/O	
26		COM	
27	B-	DC Negative	Module ground terminal.
28	B+	DC Positive	DC(8~35)V, controller power supply.
29	S1 CLOSE INPUT	S1 Close Input	Detect S1 close status, volts free contact input. Ground (B-) connected is active.
30	S2 CLOSE INPUT	S2 Close Input	Detect S2 close status, volts free contact input. Ground (B-) connected is active.
31	AUX. INPUT 1	Digital Input 1	Default: Not Used. Ground (B-) connected is active.
32	AUX. INPUT 2	Digital Input 2	Default: Not Used. Ground (B-) connected is active.
33	AUX. INPUT 3	Digital Input 3	Default: Not Used. Ground (B-) connected is active.
34	AUX. INPUT 4	Digital Input 4	Default: Not Used. Ground (B-) connected is active.
35	AUX. INPUT 5	Digital Input 5	Default: Not Used. Ground (B-) connected is active.
36	AUX. INPUT 6	Digital Input 6	Default: Not Used. Ground (B-) connected is active.
37	AUX. INPUT 7	Digital Input 7	Default: Not Used. Ground (B-) connected is active.

No.	Items	Description	Remark
38	AUX. INPUT 8	Digital Input 8	Default: Not Used. Ground (B-) connected is active.
39	AUX. OUTPUT 5	Aux. Output Port 5	Default: Not Used. Volts free relay; Normally Open output. Capacity: 10A AC250V.
40			
41	AUX. OUTPUT 6	Aux. Output Port 6	Default: Not Used. Volts free relay; Normally Open output. Capacity: 10A AC250V.
42			
43	AUX. OUTPUT 7	Aux. Output Port 7	Default: Not Used. Volts free relay; Normally Open output. Capacity: 10A AC250V.
44			
45	AUX. OUTPUT 8	Aux. Output Port 8	Default: Not Used. Volts free relay; Normally Open output. Capacity: 10A AC250V.
46			
47	AUX. OUTPUT 9	COM	Default: Genset Start, Normally Close Output. Volts free relay; Normally Open/Close output. Capacity: 8A AC250V.
48		N/C	
49		N/O	
50	AUX. OUTPUT 10	COM	Default: Not Used. Volts free relay; Normally Open/Close output. Capacity: 8A AC250V.
51		N/C	
52		N/O	
53	RS485-2 B(-)	RS485-2 Communication Port	120Ω impedance matched resistance should be connected according to the different situation.
54	RS485-2 A(+)		
55	PE	Ground Terminal	
56	RS485-1 B(-)	RS485-1 Communication Port	120Ω impedance matched resistance should be connected according to the different situation.
57	RS485-1 A(+)		
USB	USB	D-type USB Communication Port	Parameters setting and software upgrading via PC

**14.2 CONTROLLER AC/DC SUPPLY DESCRIPTION**

**14.2.1 AC SUPPLY**

Controller has independent AC supply port. Power supply can be phase voltage (L-N) or line voltage (L-L), supply range AC(90~576)V.

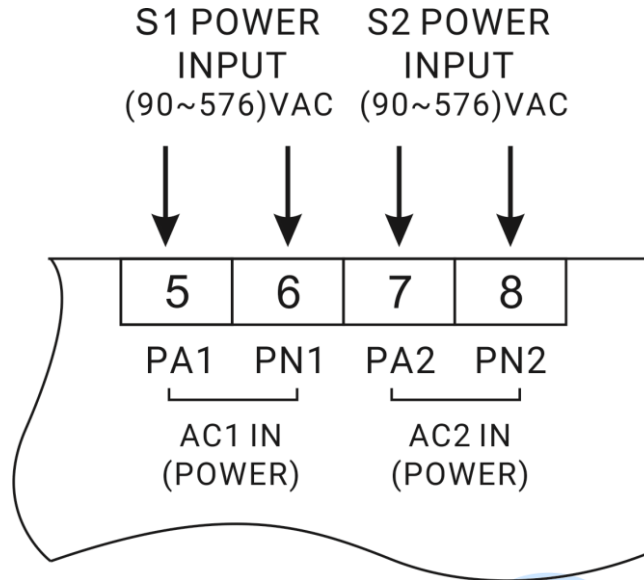
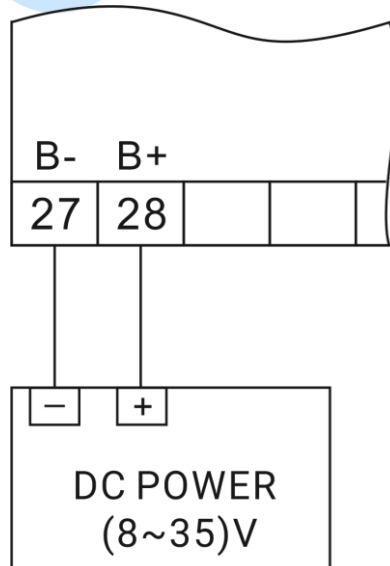

**Fig.10 – AC Supply Diagram**

**▲NOTE:** Fast transfer function only active in AC power supply!

**14.2.2 DC SUPPLY**

Controller has DC supply function, supply range (8~35)VDC.



**Fig.11 – DC Supply Diagram**

15 TYPICAL WIRING DIAGRAM

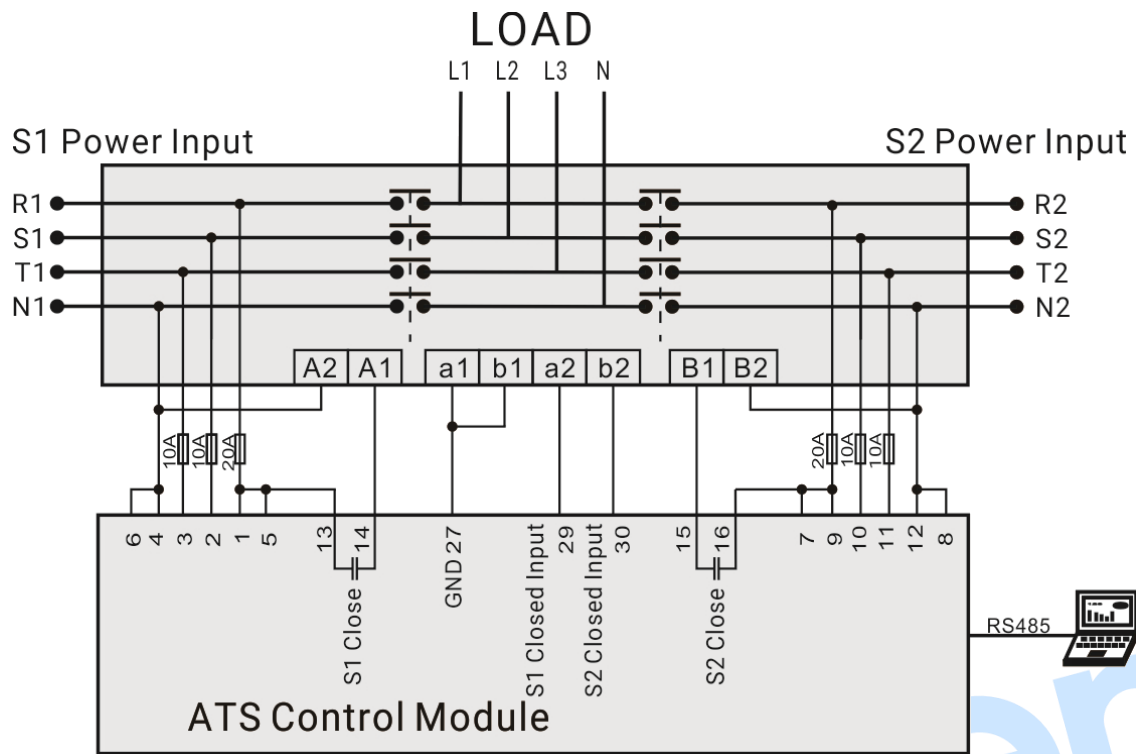

Fig.12 – Typical Application Diagram

**NOTE:** The diagram above is only for example, please do wiring according to actual conditions.

## 16 IMPORTANT TIPS

- 1) Fast transfer function only active when the single power outage;
- 2) When both power supplies are active (including abnormal situation), synchronous transfer will be executed;
- 3) This controller only suits for two-stage transfer switch;
- 4) The control coil of switch must be powered by this circuit's A phase.

## 17 INSTALLATION

Controller is panel built-in design; it is fixed by clips when installed.

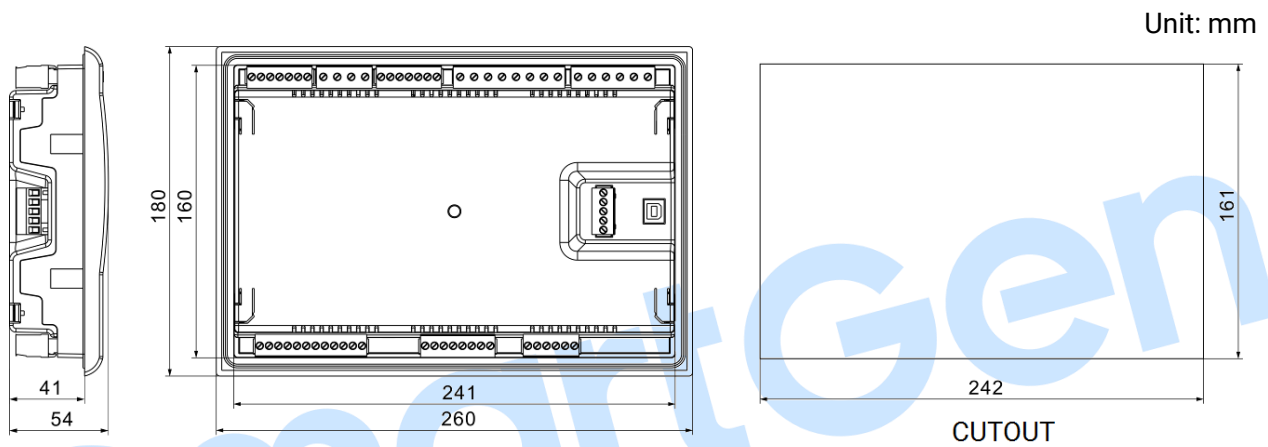

**Fig.13 – Overall & Cutout Dimensions**

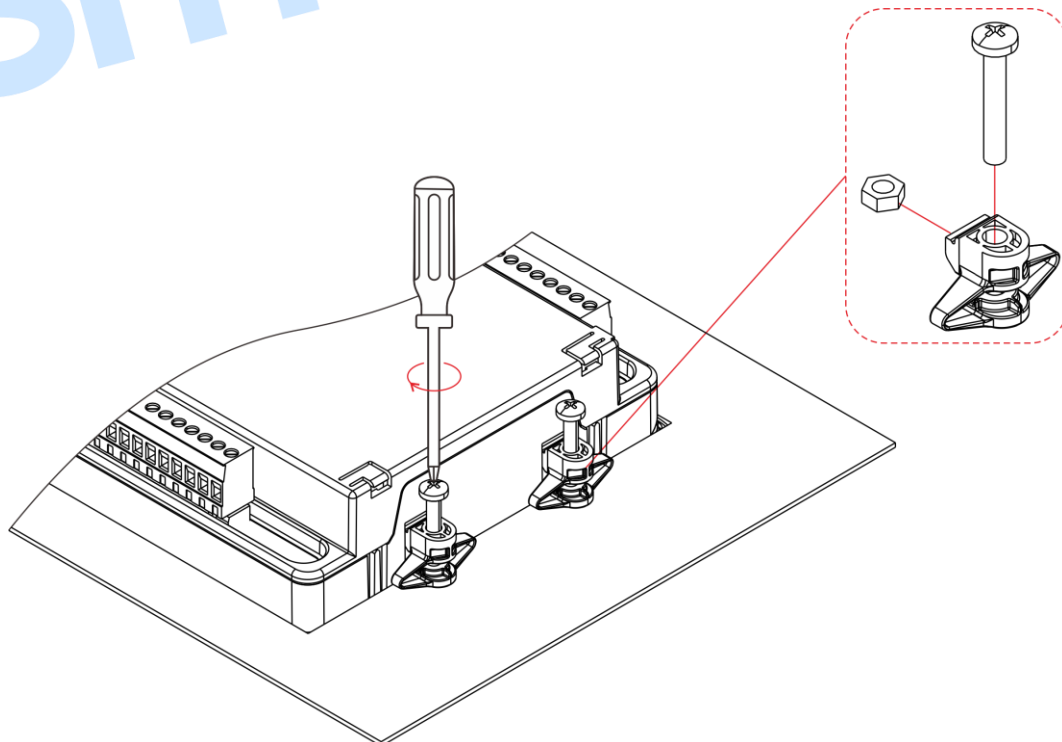

**Fig.14 – Clips Installation**

Table 23 – Troubleshooting

Symptoms	Possible Solutions
Controller No Response	Check DC voltage; Check DC fuse; Check AC power supply.
RS485 Communication Abnormal	Check RS485's positive and negative are correctly connected or not; Check RS485 converter (if configured) is normal or not; Check communication parameter setting in parameters configuration is correct or not; If above methods can't solve the problem, parallel connect 120Ω resistor between RS485 A terminal and B terminal is recommended.
Auxiliary Output Error	Check auxiliary output port connections, pay attention to normally open contact and normally close contact; Check the output port function settings and output types in parameters configuration.
Auxiliary Input Abnormal	Check whether the auxiliary input is soundly connected to GND when it is active, while hung up when it is inactive ( <b>NOTE:</b> The input port will be possibly damaged when connected with high voltage.); Check the input port function settings and active types in parameters configuration.
ATS Transfer Abnormal	Check ATS; Check the connection wirings between controller and ATS; Check ATS related parameter setting.
Fast Transfer Time Over 20ms	Check controller AC power supply is normal or not; Transfer time of high speed switch must be less than 5ms.
Genset Start Abnormal	Check system type setting; Check the output port function settings and output types; Check all Start/Stop settings.