



SmartGen
ideas for power

HAT780

DUAL POWER BYPASS ATS CONTROLLER

USER MANUAL



SMARTGEN (ZHENGZHOU) TECHNOLOGY CO., LTD.



Chinese trademark

SmartGen English trademark

SmartGen — make your generator *smart*

SmartGen Technology Co., Ltd.

No.28 Jinsuo Road

Zhengzhou

Henan Province

P. R. China

Tel: 0086-371-67988888/67981888

0086-371-67991553/67993751

0086-371-67981000(overseas)

Fax: 0086-371-67993752

Web: www.smartgen.com.cn

www.smartgen.cn

Email: sales@smartgen.cn

All rights reserved. No part of this publication may be reproduced in any material form (including photocopying or storing in any medium by electronic means or other) without the written permission of the copyright holder.

Applications for the copyright holder's written permission to reproduce any part of this publication should be addressed to SmartGen Technology at the address above.

Any reference to trademarked product names used within this publication is owned by their respective companies.

SmartGen Technology reserves the right to change the contents of this document without prior notice.

Table 1 - Software Version

Date	Version	Note
2018-10-10	1.0	Original release.
2019-04-19	1.1	Fixed the terminal function description.

CONTENT

1	OVERVIEW	4
2	PERFORMANCE AND CHARACTERISTICS	4
3	SPECIFICATION.....	5
4	MEASURE AND DISPLAY DATA.....	6
5	OPERATION	7
5.1	INDICATORS	7
5.2	KEY FUNCTION DESCRIPTION.....	8
6	LCD DISPLAY	9
6.1	MAIN SCREEN	9
6.2	STATUS DESCRIPTION.....	11
6.3	MAIN MENU.....	14
7	START/STOP OPERATION	14
7.1	MANUAL START/STOP	14
7.1.1	PANEL START/STOP	14
7.1.2	REMOTE START/STOP	15
7.2	AUTO START/STOP.....	15
7.2.1	INPUT PORT START/STOP OPERATION	15
7.2.2	“S1 GENS S2 GENS” START/STOP	15
7.2.3	SCHEDULED RUN.....	16
7.2.4	SCHEDULED NOT RUN	17
8	PARAMETERS CONFIGURATION.....	17
8.1	ILLUSTRATION	17
8.2	PARAMETERS CONFIGURATION TABLE	17
8.3	INPUT/OUTPUT FUNCTION DESCRIPTION	25
8.3.1	INPUT PORTS FUNCTION.....	25
8.3.2	OUTPUT PORTS FUNCTION.....	27
8.3.3	CUSTOM PERIOD OUTPUT	29
9	EVENT LOG.....	30
10	ATS OPERATION	31
10.1	MANUAL OPERATION	31
10.2	AUTOMATIC OPERATION	32
11	ATS POWER SUPPLY.....	32
12	COMMUNICATION CONFIGURATION.....	33
13	DESCRIPTION OF CONNECTING TERMINALS	34
14	TYPICAL WIRING DIAGRAM	37
15	INSTALLATION	39
16	FAULT FINDING	40

1 OVERVIEW

HAT780 dual power bypass ATS controller is an intelligent dual-supply module with configurable function, automatic measurement, LCD display, and digital communication. It combines digitization, intelligence and networking. Automatic measurement and control can reduce incorrect operation. It is an ideal option for dual power bypass ATS.

The powerful Microprocessor contained within the unit allows for precision voltage (2-way-3-phase) measuring and make accurate judgment; in addition, the corresponding digital output port will active when there is over/under voltage, over/under frequency, loss of phase and other abnormal condition occurs. This controller has full consideration in various application of bypass ATS (automatic transfer system) and can be directly used for single bypass ATS and dual bypass ATS as well as manual/remote control ATS. It has compact structure, advanced circuits, simple wiring and high reliability, and can be widely used in electrical devices, automatic control and testing system of electric power, telecommunications, petroleum, coal, metallurgy, railways, municipal administration, intelligent building, etc.

2 PERFORMANCE AND CHARACTERISTICS

- System type can set as: S1 Mains S2 Mains, S1 Mains S2 Gen, S1 Gen S2 Mains, S1 Gen S2 Gen;
- 132x64 LCD with backlight, multilingual interface (including English, simplified Chinese or other languages), push-button operation;
- Collect and display 2-way 3-phase voltage, frequency and phase;
- LCD displays position state of the main switch (work position, test position and isolation position) as well as state of bypass switch;
- Display S1/S2 main switch and bypass switch total close times;
- Display present continues power supply time and S1/S2 total power supply time;
- For stored-energy type ATS, its close relay will active after the PF input is active;
- Over/under voltage, loss of phase, reverse phase sequence, over/under frequency protection;
- Automatic/Manual mode. In manual mode, can force the switch to close or open;
- All parameters can be set on site. Passwords authentication ensures authorized staff operation only;
- The genset can be manual test on site to achieve start/stop operation;
- Main switch has function of automatic re-closing and close again when power off;
- Applicable for single-bypass, dual-bypass and mutual backup dual-bypass ATS;
- Applicable for manual control ATS and remote control ATS;
- Applicable for 2 isolated neutral line;
- Real-time clock (RTC); Event log function (event log can record 99 items circularly);
- Scheduled Run & Scheduled Not Run (can be set as start genset once a day/week/month whether with load or not).
- Can control two generators to work as Cycle Run mode, Master Run mode and Balance Run mode.
- Widely power supply range allows the controller can bear 80V instantaneous current;
- Large terminal space allows the controller can bear maximum 625V input voltage;
- With RS485 isolated communication interface. With "remote controlling, remote measuring, remote communication, remote regulating" function by the ModBus communication protocol. Can

remote start/stop the genset and remote control the ATS to close or open.

- USB interface enables debug parameters locally and upgrade program;
- Suitable for various AC systems (3 phase 4-wires, 3-phase 3-wires, single-phase 2-wire, and 2-phase 3-wire).
- Modular design, self extinguishing ABS plastic shell, pluggable terminal, built-in mounting, compact structure with easy installation.

3 SPECIFICATION

Table 2 - Specification

Items	Contents	
Operating Voltage	1. DC 8.0V~35.0V, continuous power supply. 2. AC90V~305V during AC power supply A1N1/A2N2.	
Power Consumption	<5W (Standby mode: ≤2W)	
AC Voltage Input	AC system	Range
	3P4W (L-N)	(50~305)V
	3P3W (L-L)	(80~625)V(need DC supply)
	1P2W (L-N)	(50~305)V
	2P3W (A-B)	(80~530)V
Rated Frequency	50/60Hz	
Main Switch Close Relay Output	16A AC250V Volts free output	
Programmable Relay Output Capacity	16A/8A AC250V Volts free output	
Digital Input	GND (B-) connect is active.	
Communication	1. RS485 isolated interface, MODBUS Protocol; 2. D-type USB	
Case Dimensions	209mmx166mmx45mm	
Panel Cutout	186mmx141mm	
Working Conditions	Temperature: (-25~+70)°C; Relative Humidity: (20~93)%RH	
Storage Condition	Temperature: (-25~+70)°C	
Protection Level	IP65: when water-proof gasket installed between control panel and enclosure.	
Insulation Strength	Apply AC2.2kV voltage between high voltage terminal and low voltage terminal; The leakage current is not more than 3.5mA within 1min.	
Weight	0.9kg	

4 MEASURE AND DISPLAY DATA

Table 3 – Measure and Display Data

No.	Measure & Display Data Items
1	S1/S2 Power Phase Voltage (L1-N,L2-N,L3-N)
2	S1/S2 Power Line Voltage (L1-L2,L2-L3,L3-L1)
3	S1/S2 Power Voltage Phase (L1-L2-L3)
4	S1/S2 Power Frequency
5	Continuous Power Supply Time
6	Continuous Power Supply Time (Last Time)
7	S1 Total Power Supply Time
8	S2 Total Power Supply Time
9	S1 Total Close Times
10	S2 Total Close Times
11	S1 Bypass Total Close Times
12	S2 Bypass Total Close Times
13	Real Time Clock
14	Event Log

5 OPERATION

5.1 INDICATORS

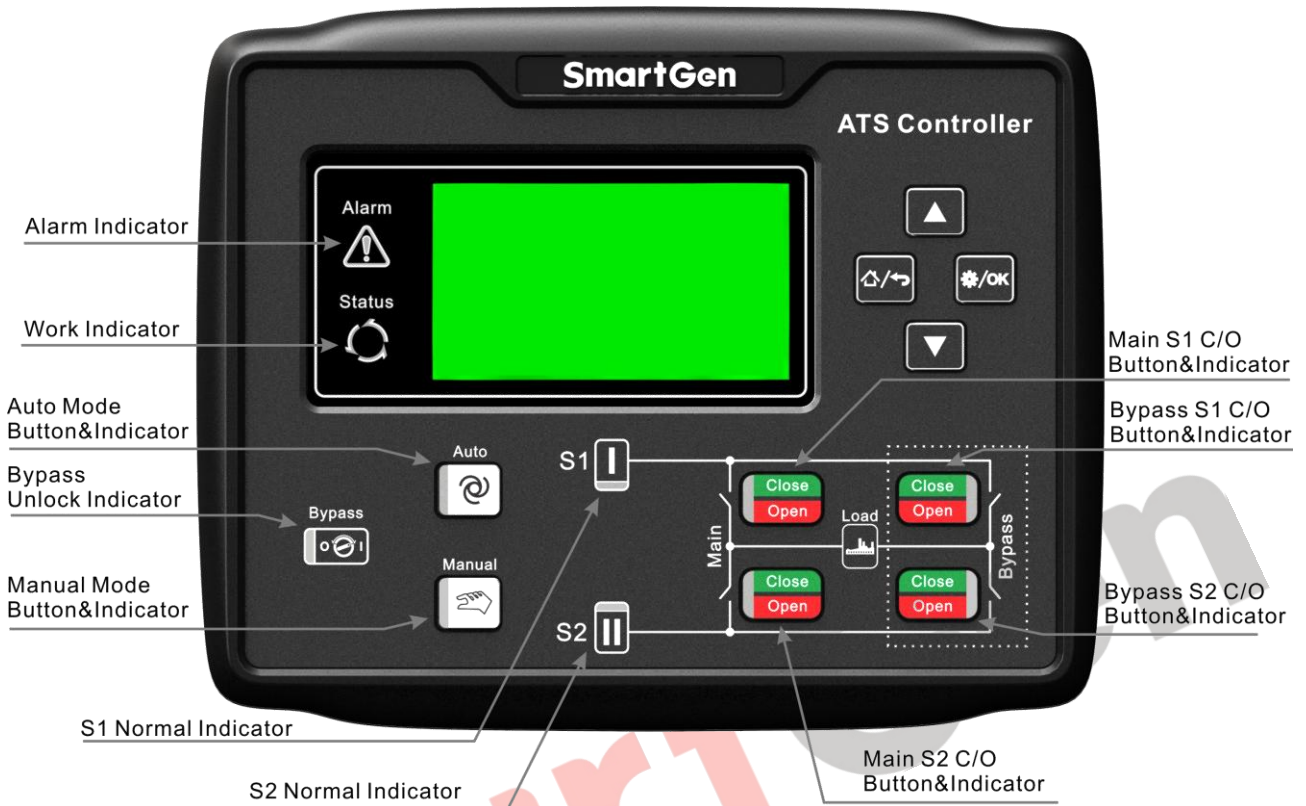

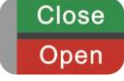

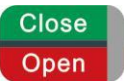
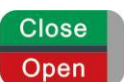





Fig.1 – Panel Indication

Table 4 – Indicators Description

Indicator Type	Color	Description
Alarm	Red	Slow flashing (1time per sec) when warn alarm occurs. Fast flashing (5 times per sec) when fault alarm occurs.
Running	Green	Flash when module countdown running (1time per sec)
S1 Power Indicator	Red	It is light on when S1 is normal; flashing when S1 is abnormal (1 time per sec); off when there is no S1 power.
S2 Power Indicator	Red	It is light on when S2 is normal; flashing when S2 is abnormal (1time per sec); off when there is no S2 power.
Main S1 Close Status	Red	It is light on when main S1 close input is activated.
Main S2 Close Status	Red	It is light on when main S2 close input is activated.
Bypass S1 Close Status	Red	It is light on when bypass S1 close input is activated.
Bypass S2 Close Status	Red	It is light on when bypass S2 close input is activated.
Manual Mode	Red	It is light on when the module is in Manual mode.
Auto Mode	Green	It is light on when the module is in Auto mode.
Bypass Unlatched	Yellow	It is light on when the bypass switch is unlatched.

5.2 KEY FUNCTION DESCRIPTION

Table 5 – Key Function Description

Icon	Button Name	Function Description
	Main S1 Close/Open	Active in Manual mode and bypass is latched (or main switch is unlatched). Press this key, if main S1 is opened, then the main S1 closing relay will be energized; if main S1 is closed, then the main S1 opening relay will be energized.
	Main S2 Close/Open	Active in Manual mode and bypass is latched (or main switch is unlatched). Press this key, if main S2 is opened, then the main S2 closing relay will be energized; if main S2 is closed, then the main S2 opening relay will be energized.
	Bypass S1 Close/Open	Active in Manual mode and bypass is unlatched. Press this key, if bypass S1 is opened, then the bypass S1 closing relay will be energized(take on load); if bypass S1 is closed, then the bypass S1 opening relay will be energized.
	Bypass S2 Close/Open	Active in Manual mode and bypass is unlatched. Press this key, if bypass S2 is opened, then the bypass S2 closing relay will be energized(take on load); if bypass S2 is closed, then the bypass S2 opening relay will be energized.
	Manual Mode	Set controller as Manual mode.
	Auto Mode	Set controller as Auto mode.
	Home/Return	Press this key to return to homepage. When setting parameters, press the key to return back to previous menu. When alarms occur, hold and press this key to enter into alarm page, and press it again can mute fault alarms.
	Set/Confirm	In main screen, hold and press the key to enter to menu. In menu screen, press this key can turn page to display. After entering menu, this key can move cursor and confirm setting information.
	Up/Increase	In main screen, press the key to scroll up screen. In menu interface, press this key to up cursor or increase value in setting menu.
	Down/Decrease	In main screen, press the key to scroll down screen. In menu interface, press this key to down cursor or decrease value in setting menu. In main screen, press the key for seconds to enter lamp test mode, all LED lamps are lit and LCD screen display black.

6 LCD DISPLAY

6.1 MAIN SCREEN

Status	
S1 Normal S2 Inactive Genset Standby S1 Main Switch On Load ATSE In Work	S1 Voltage Status S2 Voltage Status Genset Status Switch Status Current Mode, Alarm Status, Indications, Others
Power	
U1LL 380 380 380V U1LN 220 220 220V Phase 0 120 240° F1 50.00Hz BAT 27.5V ATSE In Work	S1 Line Voltage (L1-L2、 L2-L3、 L3-L1) S1 Phase Voltage S1 Phase S1 Frequency and genset battery voltage Current Mode, Alarm Status, Indications, Others
U2LL 0 0 0V U2LN 0 0 0V Phase #### ##° F2 0.00Hz Load 100% ATSE In Work	S2 Line Voltage(L1-L2、 L2-L3、 L3-L1) S2 Phase Voltage S2 Phase S2 Frequency Current Mode, Alarm Status, Indications, Others
Total	
Cont. Power Supply Time 5:25:18 Last Cont. Power Supply 8:15:37 ATSE In Work	Cont. Power Supply Time HH: MM: SS Last Cont. Power Supply HH: MM: SS Current Mode, Alarm Status, Indications, Others
S1 Total Supply Time 125:25:18 S2 Total Supply Time 35:43:37 ATSE In Work	S1 Total Supply Time HH: MM: SS S2 Total Supply Time HH: MM: SS Current Mode, Alarm Status, Indications, Others
S1 Total Close Nums 25 S2 Total Close Nums 13 ATSE In Work	S1 Total Close Times S2 Total Close Times Current Mode, Alarm Status, Indications, Others
Bypass S1 Total Close Nums 12 Bypass S2 Total Close Nums 23 ATSE In Work	Bypass S1 Total Close Times Bypass S2 Total Close Times Current Mode, Alarm Status, Indications, Others



Alarms		
Alarms	1/2	Alarm number and account
Warn Alarm		Alarm type (Warn Alarm、Fault Alarm)
Force Open Warn		Alarm event
Fault Alarm		Alarm type (Warn Alarm、Fault Alarm)
S1 Failed to Closed		Alarm event
Others		
S1 S2 1 2 3 4 5 6 7 8 9 10		Inputs, outputs number
IN		Input status, S1/S2 closing input, 1~48 are configurable ports
OUT		Output status, S1/S2 closing output, 1~10 are configurable ports
2014-09-09(2)16:53:24		Real-time clock
ATSE In Work		Current Mode, Alarm Status, Indications, Others
RS485		
Address	1	RS485 Communication and Status
Baud Rate	9600bps	Communication Address
Stop Bit	2bit	RS485 Baud Rate
ATSE In Work		RS485 Stop Bit
		Current Mode, Alarm Status, Indications, Others

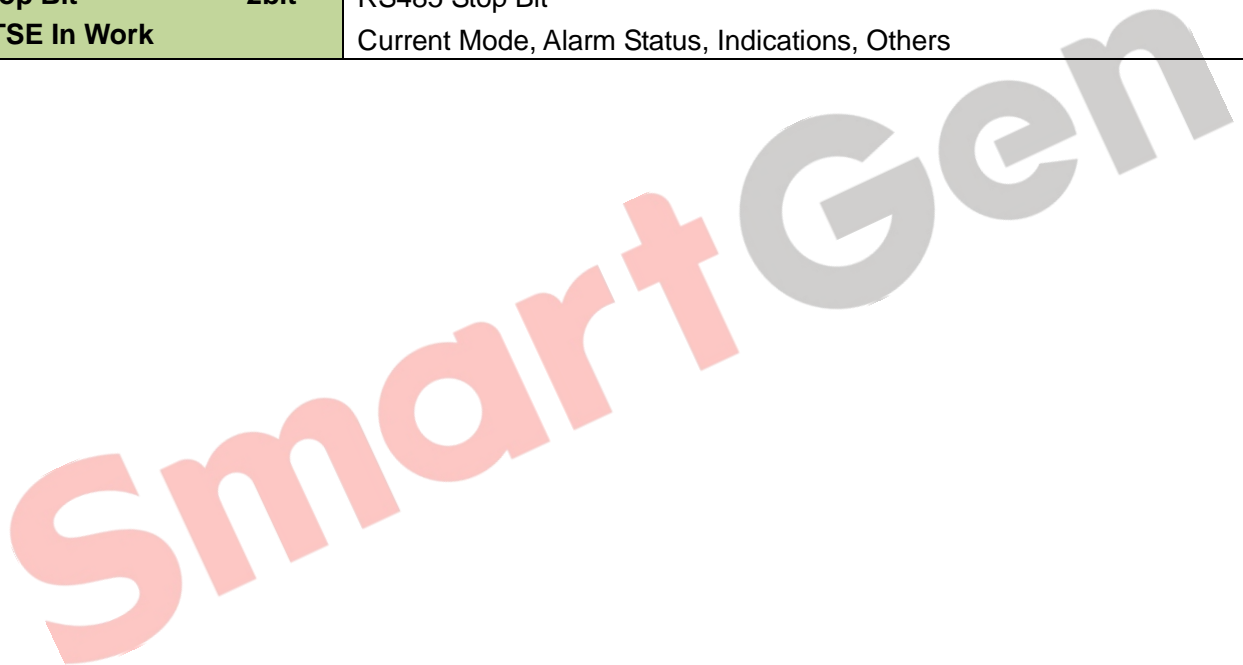

6.2 STATUS DESCRIPTION

Table 6 - S1 Voltage Status

No.	Item	Description
1	S1 Available	S1 Normal Delay
2	S1 Unavailable	S1 Abnormal Delay
3	S1 Available	Power supply voltage is within the setting range.
4	S1 Blackout	Voltage is 0.
5	S1 Over Volt	Voltage is higher than the set value.
6	S1 Under Volt	Voltage has fallen below the set value.
7	S1 Over Freq	Frequency is higher than the set value.
8	S1 Under Freq	Frequency has fallen below the set value.
9	S1 Loss of Phase	Loss of any phase of A, B and C.
10	S1 Phase Seq Wrong	A-B-C phase sequence is wrong.

Table 7 - S2 Voltage Status

No.	Item	Description
1	S2 Available	S2 Normal Delay
2	S2 Unavailable	S2 Abnormal Delay
3	S2 Available	Power supply voltage is within the setting range.
4	S2 Blackout	Voltage is 0.
5	S2 Over Volt	Voltage is higher than the set value.
6	S2 Under Volt	Voltage has fallen below the set value.
7	S2 Over Freq	Frequency is higher than the set value.
8	S2 Under Freq	Frequency has fallen below the set value.
9	S2 Loss of Phase	Loss of any phase of A, B and C.
10	S2 Phase Seq Wrong	A-B-C phase sequence is wrong.

Table 8 - Genset Status

No.	Item	Description
1	Genset Start Delay	Delay time before genset start
2	Genset Return Delay	Delay time before genset stop
3	Scheduled Not Work	When scheduled not run is active, its duration time will be displayed.
4	Scheduled Work	When scheduled run is active, its duration time will be displayed.
5	Gen1 Cycle Run	S1 cycle run countdown will be terminated when cycle start is active.
6	Gen2 Cycle Run	S2 cycle run countdown will be terminated when cycle start is active.
7	S1 Genset Working	Active when system type is "S1 Gen S2 Gen".
8	S2 Genset Working	Active when system type is "S1 Gen S2 Gen".
9	Genset Working	Genset start signal output.
10	Genset Standby	There is no start genset signal output.

Table 9 - Switch Status

No.	Item	Description
1	Ready to Transfer	Switch transfer begins.
2	Closing S1	S1 closing delay is in progress.
3	Opening S1	S1 opening delay is in progress.
4	Closing S2	S2 closing delay is in progress.
5	Opening S2	S2 opening delay is in progress.
6	Transfer Rest	Interval time between switch transfer
7	Closing S1 Again	When the S1 "Fail to open" condition occurs, it's the delay time before the close relay is active for the second time.
8	Opening S1 Again	When the S1 "Fail to close" condition occurs, it's the delay time before the open relay is active for the second time.
9	Closing S2 Again	When the S2 "Fail to open" condition occurs, it's the delay time before the close relay is active for the second time.
10	Opening S2 Again	When the S2 "Fail to close" condition occurs, it's the delay time before the open relay is active for the second time.
11	Waiting S1 PF	Before S1 is closed, it's the delay time to confirm "S1 PF Input" signal is active.
12	Waiting S2 PF	Before S2 is closed, it's the delay time to confirm "S2 PF Input" signal is active.
13	Elevator Delay	Elevator control output before ATS transfer.
14	S1 Main Switch On Load	Main switch S1 was already closed and S1 is taking load.
15	S2 Main Switch On Load	Main switch S2 was already closed and S2 is taking load.
16	Offload	Switch was already opened and load is disconnected.
17	Closing Bypass S1	Bypass S1 is closing.
18	Opening Bypass S1	Bypass S1 is opening.
19	Closing Bypass S2	Bypass S2 is closing.
20	Opening Bypass S2	Bypass S2 is opening.
21	Bypass S1 On Load	Main switch was already opened and bypass S1 was closed.
22	Bypass S2 On Load	Main switch was already opened and bypass S2 was closed.
23	S1 Sync On Load	Main switch S1 was already closed and bypass switch S1 was closed.
24	S2 Sync On Load	Main switch S2 was already closed and bypass switch S2 was opened.

Warn alarms are active when controller detects the alarm signals. Alarm indicator will flash slowly (1time per sec) while illuminated when alarm reset. Warn alarms are not latched.

Table 10 – Warn Alarms

No.	Item	Description
1	Forced Open Warn	When the input is active and the action select “Warn”, it will initiate a warning alarm.
2	Battery Under Volt	When the battery voltage has fallen below the pre-set value, it will initiate a warning alarm.
3	Battery Over Volt	When the battery voltage has exceeded the pre-set value, it will initiate a warning alarm.
4	Parallel Power Supply	When switch is in working position, both main switch and bypass switch close in the same side (S1 side or S2 side) at the same time.

Fault alarms are active when controller detects the alarm signals. Alarm indicator will flash rapidly (5 times per sec) and the alarm will last until it was removed manually. Fault alarms are latched.

Table 11 – Fault Alarms

No.	Item	Description
1	S1 Failed to Close	In Auto mode, S1 close failure is occurs.
2	S1 Failed to Open	In Auto mode, S1 open failure is occurs.
3	S2 Failed to Close	In Auto mode, S2 close failure is occurs.
4	S2 Failed to Open	In Auto mode, S2 open failure is occurs.
5	Forced Open Fault	When the “Force Open” (fire input) is active and the action select “Fault”, it will initiate a fault alarm.
6	S1 Genset Fault	When “S1 Gens S2 Gens” system is selected, S1 fails to start, it will initiate a fault alarm.
7	S2 Genset Fault	When “S1 Gens S2 Gens” system is selected, S2 fails to start, it will initiate a fault alarm.
8	Switch Trip Alarm	It will initiate a fault alarm when the input is active.

The indication information will continuously display for 2s after it is active.

Table 12 – Indication Information

No.	Item	Description
1	Please reset the alarm	When there is fault alarm occurs, the indication will be displayed when change the genset mode to Auto Mode manually.
2	S1 was already closed.	After S1 was already closed, the indication will be displayed when “S2 close” button is pressed.
3	S2 was already closed.	After S2 was already closed, the indication will be displayed when “S1 close” button is pressed.
4	Panel Locked	When panel lock is active, the indication as pressing panel button (expect Up/Down, Confirm and Return button).

Table 13 – Other Status Information

No.	Item	Description
1	ATSE In Test	Main switch ATSE is in test position.
2	ATSE In Isolation	Main switch ATSE is in isolation position.
3	Bypass In Test	Bypass switch is in test position.
4	Bypass In Isolation	Bypass switch is in isolation position.
5	Bypass Unlocked	Bypass switch has been unlocked, and can be controlled to transfer.
6	Start Inhibit	Genset start Inhibit is active.
7	S1 Load Inhibit	S1 Load Inhibit input is active.
8	S2 Load Inhibit	S2 Load Inhibit input is active.
9	Remote Gen On Load	Remote start (on load) signal is active.
10	Remote Gen Off Load	Remote start (off load) signal is active.
11	Gen Start Mains NG	Start genset when mains is abnormal.
12	Cycle Gen Start Mode	Cycle Run Start Mode is active when “S1 Gens S2 Gens” system is active.
13	Balance Gen Hours Mode	Balance Run Start Mode is active when “S1 Gens S2 Gens” system is active.
14	Master-Slave Gen Start Mode	Master Run Start Mode is active when “S1 Gens S2 Gens” system is active.
15	ATSE In Work	Main switch ATSE is in work position.
16	Auto Mode	Current mode is Auto mode.
17	Manual Mode	Current mode is Manual mode.

6.3 MAIN MENU

In the main screen, hold and press  key will enter into the menu interface.

1.Configuration 2.Data Calibration 3.Historical Records 4.Start/Stop Genset 5.About	Press Up/Down key to choose parameters (the current line was highlighted with black) and then press Confirm key to enter into the corresponding display screen.
--	---

 **NOTE:** Default password is 01234, user can change it in case of others change the parameters setting. Please clearly remember the password after changing. If you forget it, please contact SmartGen services.

 **NOTE:** Data Calibration is for factory use only and correct passwords must be input before entered.

7 START/STOP OPERATION

7.1 MANUAL START/STOP

7.1.1 PANEL START/STOP

In the main screen, hold and press  key to enter into menu page, and then select manual

start/stop and press  to confirm the action, controller will enter into manual start/stop operation interface directly.

1.Return 2.Stop Genset 3.Start Genset	Press Up/Down key to choose parameters (the current line was highlighted with black) and then press Confirm key to confirm.
--	---

Genset Stop: Disconnect the start signal, i.e. stop the running genset.

Genset Start: Output the start signal, i.e. start the genset.

When system is “S1 Gen S2 Gen”, manual start/stop menu interface is as follows:

1.Return 2.S1 Genset Stop 3.S1 Genset Start 4.S2 Genset Stop 5.S2 Genset Start	Press Up/Down key to choose parameters (the current line was highlighted with black) and then press Confirm key to confirm.
---	---

S1 Genset Stop: Disconnect the S1 start signal, i.e. stop the running S1 genset.

S1 Genset Start: Output the S1 start signal, i.e. start the S1 genset.

S2 Genset Stop: Disconnect the S2 start signal, i.e. stop the running S2 genset.

S2 Genset Start: Output the S2 start signal, i.e. start the S2 genset.

7.1.2 REMOTE START/STOP

Send remote start/stop signals using MODBUS protocol via RS485 port.

Remote Stop: Disconnect the start signal, i.e. stop the running genset.

Remote Start: Output the start signal, i.e. start the genset.

7.2 AUTO START/STOP

7.2.1 INPUT PORT START/STOP OPERATION

Set input port as “Remote Start On Load” or “Remote Start Off Load”, both could not be set simultaneously.

Remote Start on Load: When the input is active, genset close relay will active after genset is normal; when the input inactive, genset will stop automatically.

Remote Start off Load: When the input is active, mains close relay will active after mains is normal; genset close relay will active when the mains is abnormal while genset is normal; when the input inactive, genset will stop automatically.

7.2.2 “S1 GEN S2 GEN” START/STOP

When system is “S1 Gen S2 Gen”, input port start/stop function is as follows:

Remote Start on Load: Detect S1 or S2 start output according to start mode. Genset close relay will active after genset is normal.

Remote Start off Load: Detect S1 or S2 start output according to start mode. Both genset S1 close relay and S2 close relay are deactivated after genset start.

S1,S2 Gens Start Type: Cycls Run, Master Run, Balance Run and Not Used.

Start Mode: Cycle Run Start, Master Run Start, Balance Run Start and Not Used.

Cycle Run Start:

When remote start is active, S1 and S2 cycle run start according to the cycle run time. At the first time to start the genset, choose “S1 Start” or “S2 Start” depends on the “Master Set” information. e.g. S1 start at the first time if “S1 Master” is selected. The S1 cycle run countdown is started according to the preset delay. At the same time, genset fault delay will be initiated. If S1 genset is normal before the fault delay has expired, S1 will take load; S2 start after the preset S1 cycle run delay has expired and the S2 loading process is same as S1. S1 will stop automatically after the S2 has take load successfully. S1 and S2 will cycle run in this way alternately until the remote start signal deactivated.

During the start process, if there is genset fault alarm (genset fault delay overtime or genset fault input is active), fail to close or load inhibit alarm occurs, the starting genset will be stop immediately and the additional genset will be start automatically.

During the cycle run process, if “Auto Mode” is selected, the current status will be hold and the “cycle run countdown” will be suspended.

Master Run

Master genset will be start when remote start signal is active. During the start process, if there is genset fault alarm (genset supply delay overtime or genset fault input is active), fail to close or load inhibit alarm occurs, the starting genset will be stop immediately and the additional genset will be start automatically. Otherwise, the master run genset will running continuously until the remote start signal deactivated.

Balance Run

The gensets which has the shortest running hours will be start when remote start signal is active. During the start process, if there is genset fault alarm (genset supply delay overtime or genset fault input is active), fail to close or load inhibit alarm occurs, the starting genset will be stop immediately and the additional genset will be start automatically. Otherwise, the current genset will running continuously until the remote start signal deactivated.

In system “S1 Gens S2 Gens” to start/stop genset should meet following several conditions:

- 1) It is active in Auto mode;
- 2) System set as “S1 Gens S2 Gens”;
- 3) Output port should be set as “S1 Genset Start” and “S2 Genset Start”;
- 4) Input port should be set as “S1 Genset Fault Input”, “S2 Genset Fault Input” and “Remote Start On Load” or “Remote Start Off Load”;
- 5) Should set start mode when “S1 Gens S2 Gens” system is selected;
- 6) Should configure setting “Genset Supply Delay”, If start mode is cycle run, also should set “S1 Cycles Run Time” and “S2 Cycles Run Time”;

Among input ports, “S1 Genset Fault Input” and “S2 Genset Fault Input” are selective setting, Genset fault can be judged by “Genset Supply Delay” and there no need to inquire the fault alarm via input port.

When S1, S2 start type configured as “Not Used”, there is no start genset signals output

7.2.3 SCHEDULED RUN

Once *Scheduled Run* enables, users can set the scheduled start time. Controller will send start signal at preset start time. Start signal will deactivated after the start delay has expired.

Scheduled Run On Load or Scheduled Run Off Load can be set.

Scheduled Run On Load: When the input is active, genset close relay will active after genset is

normal.

Scheduled Run Off Load: When the input is active, mains close relay will active after mains is normal; genset close relay will active when the mains is abnormal while genset is normal.

Cycle time of *Scheduled Run* can be set as start monthly, weekly and daily.

Run Monthly: Monthly start date and time can be set.

Run Weekly: Can start the genset at the same time in couple days of a week. Eg. Start the genset at 8:00 a.m. from Monday to Friday and keep 10 hours.

Run Daily: Can start the genset at same time every day.

7.2.4 SCHEDULED NOT RUN

Once *Scheduled Not Run* enables, users can set the “scheduled not start” time. Start signal will deactivated when *Scheduled Not Run* time is due and it will be inhibited before the delay has expired.

Cycle time of *Scheduled Not Run* can be set as monthly, weekly and daily.

Not Run Monthly: Monthly *Not* start Date and time can be set.



Not Run Weekly: Can not start the genset at the same time in couple days of a week. Eg. Not Start the genset at 19:00 p.m. from Monday to Friday and keep 12 hours.

Not Run Daily: Cannot start the genset at same time every day.

 **Note:** *Scheduled Not Run* operation is prior to *Scheduled Run* operation.

8 PARAMETERS CONFIGURATION

8.1 ILLUSTRATION

In the main interface, hold and press  key to enter into menu page, choose **Configuration** and press  again to enter into password confirmation interface. If password is correct, enter into parameter setting interface, otherwise, exit to main interface directly. Factory default password is **01234**. In parameters configuration interface, pressing  key to return the prior menu.

8.2 PARAMETERS CONFIGURATION TABLE

Table 14 - Parameters Item Table

No.	Item	Range	Default	Description
AC System				
1	S1 Available Delay	(0-3600) s	10	The delay from S1 voltage abnormal to normal.
2	S1 Unavailable Delay	(0-3600)s	5	The delay from S1 voltage normal to abnormal.
3	S2 Available Delay	(0-3600)s	10	The delay from S2 voltage abnormal to normal.
4	S2 Unavailable Delay	(0-3600)s	5	The delay from S2 voltage normal to abnormal.



No.	Item	Range	Default	Description
5	Master-Slave Set	(0-2)	0	0: S1 Master 1: S2 Master 2: No Master
6	System Type Set	(0-3)	0	0: S1 Mains S2 Gen 1: S1 Gen S2 Mains 2: S1 Mains S2 Mains 3: S1 Gen S2 Gen
7	AC System	(0-3)	0	0: 3-Phase, 4-Wire 1: 3-Phase, 3-Wire 2: 2-Phase, 3-Wire 3: Single Phase, 2-Wire
8	PT Fitted	(0-1)	0	0: Disable 1: Enable
9	PT Primary	(30-30000)V	100	Primary voltage of voltage transformer
10	PT Secondary	(30-1000)V	100	Secondary voltage of voltage transformer
11	Rated Voltage	(0-30000)V	220	Rated voltage of AC system
12	Over Volt	(0-1)	1	0: Disable 1: Enable
13	Over Volt Set Value	(0-200)%	120	Upper limit value of voltage; it is abnormal if the value has exceeded the set value.
14	Over Voltage Return	(0-200)%	115	Upper limit return value of voltage; it is normal only when the value has fallen below the set value.
15	Under voltage	(0-1)	1	0: Disable 1: Enable
16	Under Voltage Set Value	(0-200)%	80	Lower limit value of voltage; it is abnormal if the value has fallen below the set value.
17	Under Voltage Return Value	(0-200)%	85	Lower limit return value of voltage; it is normal only when the value has exceeded the set value.
18	Rated Frequency	(10.0-75.0)Hz	50.0	Rated frequency of AC system
19	Over Frequency	(0-1)	1	0: Disable 1: Enable
20	Over Frequency Set Value	(0-200)%	110	Upper limit value of frequency; it is abnormal if the value has exceeded the set value.
21	Over Frequency Return Value	(0- 200)%	104	Upper limit return value of frequency; it is normal only when the value has fallen below the set value.
22	Under Frequency	(0-1)	1	0: Disable 1: Enable
23	Under Frequency Set Value	(0- 200)%	90	Lower limit value of frequency; it is abnormal if the value has fallen below the set value.
24	Under Frequency Return Value	(0- 200)%	96	Lower limit return value of frequency; it is normal only when the value has exceeded the set value.
25	Phase Sequence Wrong	(0-1)	1	0: Disable 1: Enable
SWITCH SETTING				
1	Bypass Function Type	(0~1)	0	0: DBTSE 1:SBTSE
2	Bypass Switch Type	(0~2)	1	0: MTSE 1: RTSE



No.	Item	Range	Default	Description
				2:RTSE
3	ATS Power Type	(0~1)	1	0: DC Power Supply 1: AC Power Supply
4	ATS Power Low Point	(0~100)%	70	Lower limit voltage of switch power; The switch cannot transfer when the value has fallen below the set value.
5	ATS Power High Point	(0~200)%	130	Upper limit voltage of switch power; The switch cannot transfer when the value has exceeded the set value.
6	Definite C/O Time	(0-1)	0	0: Disable ; 1: Enable Disable: The output time was judged depends on the close relay; the longest output time up to the set delay. Enable: The output time last for the preset time.
7	Close Time	(0.1-20.0)s	5.0	Pulse time of close relay.
8	Open Time	(0.1-20.0)s	5.0	Pulse time of open relay.
9	Transfer Interval	(0-9999)s	1	Interval time from S1 switch open to S2 switch close; or from S2 switch open to S1 switch close.
10	Again Close Delay	(0-20.0)s	1.0	When the breaker fails to open for the first time, then the module will close for the second time and the "Again Close Delay" begins, after the delay has expired, if still failed to open for the second time, the module will send out fail to open alarm.
11	Again Open Delay	(0-20.0)s	1.0	When the breaker fails to close for the first time, then the module will open for the second time and the "Again Open Delay" begins, after the delay has expired, if still failed to close for the second time, the module will send out fail to close alarm.
12	Switch Type	(0-1)	0	0: Two Breaking 1: One Breaking
13	Forced Open Action	(0-1)	0	0: Warn Alarm 1: Fault Alarm
14	Continuously Close	(0-1)	0	0: Disable ; 1: Enable If "Enable" is selected, "Close Time" and "Open Time" are deactivated.
Generator Setting				
1	Gen Start Delay	(0-9999)s	1	When the genset is ready to start, start delay begins, after the start delay has expired, start signal will be initiated.
2	Gen Stop Delay	(0-9999)s	5	When the genset is ready to stop, stop delay begins, after the stop delay has expired, stop signal will be initiated.
3	Gen-Gen Start Mode	(0-3)	0	0: Cycles Gens



No.	Item	Range	Default	Description
				1: Master-Slave Gens 2: Balance Gens Hours 3: Not Used
4	S1 Cycles Work Time	(0-9999)min	720	Gens cycle start S1 running time.
5	S2 Cycles Work Time	(0-9999)min	720	Gens cycle start S2 running time.
6	Genset Available Time	(0-9999)s	120	When the start signal is active, the start delay will be initiated. If the gen voltage lasts abnormal after the delay has expired, "Genset Fault" alarm will be initiated.
7	Battery Volt Enable	(0-1)	0	0: Disable ; 1: Enable
8	Battery LV Warn	(0-1)	0	0: Disable ; 1: Enable
9	Battery Under Volt Set Value	(0-100.0)V	10.0	"Battery Under Volts" alarm will be initiated if the battery voltage has fallen below the set value.
10	Battery Under Volt Return Value	(0-100.0)V	10.5	"Battery Under Volts" alarm will be removed if the battery voltage has exceeded the set value.
11	Battery Under Volt Delay	(0-3600)s	60	If the battery voltage has fallen below the set value, "Battery Under Volts" alarm will be initiated after the delay has expired.
12	Battery OV Warn	(0-1)	0	0: Disable ; 1: Enable
13	Battery Over Volt Set Value	(0-100.0)V	30.0	"Battery Over Volts" alarm will be initiated if the battery voltage has exceeded the set value.
14	Battery Over Volt Return Value	(0-100.0)V	37.5	"Battery Over Volts" alarm will be removed if the battery voltage has fallen below the set value.
15	Battery Over Volt Delay	(0-3600)s	60	If the battery voltage has exceeded the set value, "Battery Over Volts" alarm will be initiated after the delay has expired.
Scheduler Config				
1	Schedule Gen Enable	(0-1)	0	0: Disable ; 1: Enable
2	Schedule Load	(0-1)	0	0: Off Load 1: On Load
3	Schedule Period	(0-2)	0	0: Monthly 1: Weekly 2: Daily
4	Schedule Monthly	(1-31)	1	The date of start the genset
5	Schedule Weekly	(1-127)	1	Bit0: Sunday Bit1: Monday Bit2: Tuesday Bit3: Wednesday Bit4: Thursday Bit5: Friday Bit6: Saturday X=Bit0*1 + Bit1*2 + Bit2*4 + Bit3*8 + Bit4*16



No.	Item	Range	Default	Description
				+ Bit5*32 + Bit6*64
6	Schedule Hours	(0-23)h	0	The time of start the genset
7	Schedule Minutes	(0-59)min	0	
8	Schedule Work Time	(0-30000)min	30	The duration time of genset running
9	Gen Inhabit Work Set	(0-1)	0	0: Disable ; 1: Enable
10	Inhabit Period	(0-2)	0	0: Monthly 1: Weekly 2: Daily
11	Inhabit Monthly	(1-31)	1	The date of <i>NOT</i> start the genset
12	Inhabit Weekly	(1-127)	1	Bit0: Sunday Bit1: Monday Bit2: Tuesday Bit3: Wednesday Bit4: Thursday Bit5: Friday Bit6: Saturday X=Bit0*1 + Bit1*2 + Bit2*4 + Bit3*8 + Bit4*16 + Bit5*32 + Bit6*64
13	Inhabit Hours	(0-23)	0	The time of <i>NOT</i> start the genset
14	Inhabit Minutes	(0-59)	0	
15	Inhabit Rest Time	(0-30000)	30	The duration time of genset <i>NOT</i> running
Load Setting				
1	Elevator Enable	(0-1)	0	0: Disable ; 1: Enable
2	Elevator Delay	(0-300)s	300	It's the delay time before the load disconnects or switch transfers. Used for control the running elevator stop at the nearest floor until the switch transfer is terminated.
Digital Input				
1	Digital Input 1	(0-40)	1	Forced Open
2	Active Type	(0-1)	0	0: Closed to activate; 1: Open to activate
3	Digital Input 2	(0-40)	8	Switch Trip Input
4	Active Type	(0-1)	0	0: Closed to activate; 1: Open to activate
5	Digital Input 3	(0-40)	28	S1 Bypass Close IN
6	Active Type	(0-1)	0	0: Closed to activate; 1: Open to activate
7	Digital Input 4	(0-40)	29	S2 Bypass Close IN
8	Active Type	(0-1)	0	0: Closed to activate; 1: Open to activate
9	Digital Input 5	(0-40)	30	Bypass Unlocked
10	Active Type	(0-1)	0	0: Closed to activate; 1: Open to activate
11	Digital Input 6	(0-40)	31	ATSE In Work

No.	Item	Range	Default	Description
12	Active Type	(0-1)	0	0: Closed to activate; 1: Open to activate
13	Digital Input 7	(0-40)	32	ATSE In Test
14	Active Type	(0-1)	0	0: Closed to activate; 1: Open to activate
15	Digital Input 8	(0-40)	0	Not Used
16	Active Type	(0-1)	0	0: Closed to activate; 1: Open to activate
Relay Output				
1	Relay Output 1	(0-1)	0	0:Normally open; 1:Normally close
2	Contents Setting	(0-103)	49	ATS Power L1
3	Relay Output 2	(0-1)	0	0:Normally open; 1:Normally close
4	Contents Setting	(0-103)	52	ATS Power N
5	Relay Output 3	(0-1)	0	0:Normally open; 1:Normally close
6	Contents Setting	(0-103)	35	S1 Open Control
7	Relay Output 4	(0-1)	0	0:Normally open; 1:Normally close
8	Contents Setting	(0-103)	37	S2 Open Control
9	Relay Output 5	(0-1)	0	0:Normally open; 1:Normally close
10	Contents Setting	(0-103)	91	S1 Bypass Open Output
11	Relay Output 6	(0-1)	0	0:Normally open; 1:Normally close
12	Contents Setting	(0-103)	93	S2 Bypass Open Output
13	Relay Output 7	(0~1)	0	0:Normally open; 1:Normally close
14	Contents Setting	(0~103)	90	S1 Bypass Close Output
15	Relay Output 8	(0~1)	0	0:Normally open; 1:Normally close
16	Contents Setting	(0~103)	92	S2 Bypass Close Output
17	Relay Output 9	(0~1)	0	0:Normally open; 1:Normally close
18	Contents Setting	(0~103)	89	Parallel Power Supply
19	Relay Output 10	(0~1)	1	0:Normally open; 1:Normally close
20	Contents Setting	(0~103)	32	Genset Start
21	Combined 1 Or Out 1 Active Type	(0-1)	0	0:Normally open; 1:Normally close
22	Combined 1 Or Out 1 Contents Setting	(0-103)	23	S1 Normal
23	Combined 1 Or Out 2 Active Type	(0-1)	0	0:Normally open; 1:Normally close



No.	Item	Range	Default	Description
24	Combined 1 Or Out 2 Contents Setting	(0-103)	25	S2 Normal
25	Combined 1 And Out Active Type	(0-1)	1	0:Normally open; 1:Normally close
26	Combined 1 And Out Contents Setting	(0-103)	0	Not Used
27	Combined 2 Or Out 1 Active Type	(0-1)	0	0:Normally open; 1:Normally close
28	Combined 2 Or Out 1 Contents Setting	(0-103)	0	Not Used
29	Combined 2 Or Out 2 Active Type	(0-1)	0	0:Normally open; 1:Normally close
30	Combined 2 Or Out 2 Contents Setting	(0-103)	0	Not Used
31	Combined 2 And Out Active Type	(0-1)	0	0:Normally open; 1:Normally close
32	Combined 2 And Out Contents Setting	(0-103)	0	Not Used
33	Combined 3 Or Out 1 Active Type	(0-1)	0	0:Normally open; 1:Normally close
34	Combined 3 Or Out 1 Contents Setting	(0-103)	0	Not Used
35	Combined 3 Or Out 2 Active Type	(0-1)	0	0:Normally open; 1:Normally close
36	Combined 3 Or Out 2 Contents Setting	(0-103)	0	Not Used
37	Combined 3 And Out Active Type	(0-1)	0	0:Normally open; 1:Normally close
38	Combined 3 And Out Contents Setting	(0-103)	0	Not Used
39	Combined 4 Or Out 1 Active Type	(0-1)	0	0:Normally open; 1:Normally close
40	Combined 4 Or Out 1 Contents Setting	(0-103)	0	Not Used
41	Combined 4 Or Out 2 Active Type	(0-1)	0	0:Normally open; 1:Normally close
42	Combined 4 Or Out 2 Contents Setting	(0-103)	0	Not Used
43	Combined 4 And Out Active Type	(0-1)	0	0:Normally open; 1:Normally close
44	Combined 4 And Out Contents Setting	(0-103)	0	Not Used
45	Combined 5 Or Out 1 Active Type	(0-1)	0	0:Normally open; 1:Normally close
46	Combined 5 Or Out 1 Contents Setting	(0-103)	0	Not Used



No.	Item	Range	Default	Description
47	Combined 5 Or Out 2 Active Type	(0-1)	0	0:Normally open; 1:Normally close
48	Combined 5 Or Out 2 Contents Setting	(0-103)	0	Not Used
49	Combined 5 And Out Active Type	(0-1)	0	0:Normally open; 1:Normally close
50	Combined 5 And Out Contents Setting	(0-103)	0	Not Used
51	Combined 6 Or Out 1 Active Type	(0-1)	0	0:Normally open; 1:Normally close
52	Combined 6 Or Out 1 Contents Setting	(0-103)	0	Not Used
53	Combined 6 Or Out 2 Active Type	(0-1)	0	0:Normally open; 1:Normally close
54	Combined 6 Or Out 2 Contents Setting	(0-103)	0	Not Used
55	Combined 6 And Out Active Type	(0-1)	0	0:Normally open; 1:Normally close
56	Combined 6 And Out Contents Setting	(0-103)	0	Not Used
Module Setting				
1	Power On Mode	(0-2)	0	0: Previous Mode (Keep the working mode last time running) 1: Manual 2: Auto
2	Module Address	(1-254)	1	RS485 communication address
3	Language	(0-2)	0	0: Simplified Chinese 1: English 2: Others (Language can be set via PC software)
4	Password	(00000-65535)	01234	For entering parameters setting.
5	Baud Rate	(0-3)	2	0: 2400bps 1: 4800bps 2: 9600bps 3: 19200bps
6	Stop Bit	(1-2)	2	2 stop bits or 1 stop bit can be set.
7	Date and Time			

8.3 INPUT/OUTPUT FUNCTION DESCRIPTION

8.3.1 INPUT PORTS FUNCTION

Table 15 – Input Port Function Description

No.	Item	Description
0	Not used	Invalid
1	Forced Open	It only suits for breaker with open controlling. No matter the genset is in manual mode or Auto mode, when the input is active, this will force the breaker to transfer the ATS to OFF position.
2	Remote Start on Load	When active, controller will send genset start signal immediately. When mains is normal, genset will close the breaker.
3	Remote Start Off Load	When active, controller will send a genset start signal immediately. When mains is normal, genset will not close the breaker.
4	Test lamp	When active, all LED lights on the front panel are illuminated and the backlight of the LCD is illuminated while the LCD screen is black in color.
5	Gen1 Fault Input	In Cycle start, if the input is active, S1 Gens start will be inhibited.
6	Gen2 Fault Input	In Cycle start, if the input is active, S2 Gens start will be inhibited.
7	Start Inhibit Input	In Auto mode, start signal will deactivated after the stop delay has expired. In Manual mode, if the genset is running, users should stop it manually; then the manual start signal will deactivated.
8	Breaker Trip Input	Trip failure input
9	S1 Close Inhibit	In Manual mode, S1 manual close is inhibited; if breaker already closed, users should open it manually. In Auto mode, if breaker already closed, then close relay will deactivated or S2 take load.
10	S2 Close Inhibit	In Manual mode, S2 manual close is inhibited; if breaker already closed, users should open it manually. In Auto mode, if breaker already closed, then close relay will deactivated or S1 take load.
11	S1 Breaker PF Input	When the S1 PF input is active, S1 close relay will activated.
12	S2 Breaker PF Input	When the S2 PF input is active, S2 close relay will activated.
13	S1 O/C Key	Simulate the panel S1 O/C button to control the S1 close/open. Self-reset button is recommended.
14	S2 O/C Key	Simulate the panel S2 O/C button to control the S2 close/open. Self-reset button is recommended.
15	Alarm Reset	Reset the current alarm.
16	Alarm Mute	Silence the audible alarm.
17	Reserved	
18	Reserved	
19	S1 Master Input	Set S1 master use compulsively.
20	S2 Master Input	Set S2 master use compulsively.
21	Forced Manual Mode	Set the controller in Manual mode compulsively.
22	Forced Auto Mode	Set the controller in Auto mode compulsively.
23	Panel Lock	Panel button operation is inhibited (Except buttons of Up, Down, Return and Confirm).



No.	Item	Description
24	Reserved	
25	Scheduler Inhibit	“Schedule Start” and “Schedule Not Start” function are deactivated.
26	Simulate S1 OK	Simulate S1 voltage is normal; the S1 voltage abnormal delay is deactivated.
27	Simulate S2 OK	Simulate S2 voltage is normal; the S2 voltage abnormal delay is deactivated.
28	S1 Bypass Close IN	S1 bypass close auxiliary input.
29	S2 Bypass Close IN	S2 bypass close auxiliary input.
30	Bypass Unlocked	When bypass unlocked input is active, bypass indicator is illuminated, and users are allowed to operate bypass switch.
31	ATSW In Work	Main switch ATSE is in work position.
32	ATSW In Test	Main switch ATSE is in test position.
33	S1 Bypass C/O Key	Simulate the panel S1 bypass O/C button to control the S1 bypass close/open. Self-reset button is recommended.
34	S2 Bypass C/O Key	Simulate the panel S2 bypass O/C button to control the S2 bypass close/open. Self-reset button is recommended.
35	ATSE Unlocked	If “ATSE Unlocked” input is active, bypass indicator will extinguish, and users are allowed to operate main switch.
36	Bypass In Work	Bypass switch is in work position.
37	Bypass In Test	Bypass switch is in test position.
38	Overhaul Unlock	At the time of maintenance, after the maintenance unlock input (self-reset button) trigger is valid, the maintenance unlock output is maintained for 1 minute.
39	Reserved	
40	Reserved	

8.3.2 OUTPUT PORTS FUNCTION

Table 16 – Output Function Description

No.	Items	Description
0	Not Used	Invalid
1	Custom Combined 1	
2	Custom Combined 2	
3	Custom Combined 3	
4	Custom Combined 4	
5	Custom Combined 5	
6	Custom Combined 6	
7	Reserved	
8	Reserved	
9	Reserved	
10	Reserved	
11	Common Alarm	It includes fault alarm and warn alarm.
12	Common Fault Alarm	It includes “Transition Fault” alarm and “Over Current Trip” alarm.
13	Common Warn Alarm	It includes “S1 Phase Sequence Wrong” alarm, “S2 Phase Sequence Wrong” alarm and “Forced Open” alarm.
14	Transition Fault	It includes “S1 Fail to Close” alarm, “S1 Fail to Open” alarm, “S2 Fail to Close” alarm, and “S2 Fail to Open” alarm.
15	Audible Alarm	Action when common alarm occurs. It can be connected with annunciator externally. When “alarm mute” input is active or 60s delay has expired, it can remove the alarm.
16	Reserved	
17	Genset Start Delay	Output when start signal is initiated.
18	Genset Stop Delay	Output when stop signal is initiated.
19	Elevator Control	Output before the load disconnects or switch transfers. Used for control the running elevator stop at the nearest floor until the switch transfer is terminated.
20	Overhaul Unlock Out	At the time of maintenance, after the maintenance unlock input (self-reset button) trigger is valid, the maintenance unlock output is maintained for 1 minute.
21	Reserved	
22	Reserved	
23	S1 Available	Output when S1 power is normal.
24	S1 Unavailable	Output when S1 power is abnormal.
25	S2 Available	Output when S2 power is normal.
26	S2 Unavailable	Output when S2 power is abnormal.
27	Reserved	
28	Reserved	
29	Reserved	
30	Auto Mode	Output when the genset is in Auto mode.
31	Manual Mode	Output when the genset is in Manual mode.



No.	Items	Description
32	Genset Start Output	Control the genset to start.
33	Reserved	
34	S1 Close Control	Control the S1 switch to close.
35	S1 Open Control	Control the S1 switch to open.
36	S2 Close Control	Control the S2 switch to close.
37	S2 Open Control	Control the S2 switch to open.
38	Reserved	
39	Reserved	
40	Reserved	
41	Reserved	
42	Reserved	
43	Reserved	
44	Reserved	
45	Breaker1 On Feedback	The close status of S1 switch
46	Breaker2 On Feedback	The close status of S2 switch
47	S1 Genset Start	When the system type is "S1 Gen S2 Gen", it controls the S1 genset start.
48	S2 Genset Start	When the system type is "S1 Gen S2 Gen", it controls the S2 genset start.
49	ATS Power L1	ATS power supply
50	ATS Power L2	
51	ATS Power L3	
52	ATS Power N	
53	Remote Control	Control the output via remote communication command.
54	Input 1 Status	Input status
55	Input 2 Status	
56	Input 3 Status	
57	Input 4 Status	
58	Input 5 Status	
59	Input 6 Status	
60	Input 7 Status	
61	Input 8 Status	
62	Reserved	
63	Reserved	
64	S1 Blackout	S1 power supply status
65	S1 Over Volt	
66	S1 Under Volt	
67	S1 Over Freq	
68	S1 Under Freq	
69	S1 Loss Of Phase	
70	S1 Phase Seq Wrong	
71	Reserved	
72	Reserved	

No.	Items	Description
73	S2 Blackout	S2 power supply status
74	S2 Over Volt	
75	S2 Under Volt	
76	S2 Over Freq	
77	S2 Under Freq	
78	S2 Loss Of Phase	
79	S2 Phase Seq Wrong	
80	Reserved	
81	Reserved	
82	Reserved	
83	Reserved	
84	Switching	Output during the switch transfer process.
85	Battery Under Volt	Output when battery under voltage alarm occurs.
86	Battery Over Volt	Output when battery over voltage alarm occurs.
87	Gen Inhabit Work	Output during the Schedule Not Run process.
88	Scheduler Gen Start	Output during the Schedule Run process.
89	Parallel Power Supply	When switch is in work position, both main switch and bypass switch closed in S1 side or S2 side.
90	S1 Bypass Close Out	Control S1 bypass to close.
91	S1 Bypass Open Out	Control S1 bypass to open.
92	S2 Bypass Close Out	Control S2 bypass to close.
93	S2 Bypass Open Out	Control S2 bypass to open.
94	S1 Bypass Closed	Output when S1 bypass has been closed.
95	S2 Bypass Closed	Output when S2 bypass has been closed.
96	Bypass Unlocked Out	Output when bypass switch has been unlocked.
97	ATSE In Work	Position status of the main switch ATSE.
98	ATSE In Test	
99	ATSE In Isolation	
100	ATSE Unlocked Out	Output when main switch ATSE has been unlocked.
101	Bypass In Work	Position status of the bypass switch.
102	Bypass In Test	
103	Bypass In Isolation	

8.3.3 CUSTOM PERIOD OUTPUT

Defined combination output is composed by 3 parts, OR condition output SW1, OR condition output SW2, AND condition output SW3.

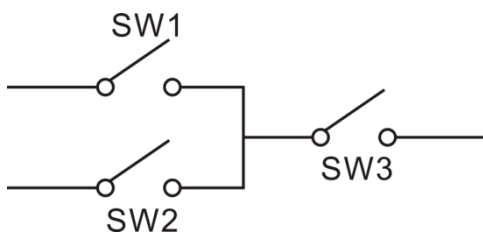

SW1 or SW2 is **TRUE**, while SW3 is **TRUE**, Defined combination output is active;

SW1 and SW2 are **FALSE**, or SW3 is **FALSE**, Defined combination output is deactivated.

NOTE: SW1, SW2, SW3 can be set as any contents except for “defined combination output” in the output setting.

NOTE: 3 parts of defined combination output (SW1, SW2, SW3) couldn't include or recursively include themselves.

Example,

Contents of OR condition output SW1: output port 1 is active;

Close when OR condition output SW1 is active /inactive: close when active (disconnect when inactive);

Contents of OR condition output SW2, output port 2 is active;

Close when OR condition output SW2 is active /inactive: close when active (disconnect when inactive);



Contents of AND condition output SW3: output port 3 is active;





Close when AND condition output SW3 is active /inactive: close when active (disconnect when inactive);

When input port 1 active or input port 2 active, if input port 3 is active, Defined combination output is **outputting**; If input port 3 inactive, Defined combination output is **not outputting**;

When input port 1 inactive and input port 2 inactive, whatever input port 3 is active or not, Defined combination output is **not outputting**.

9 EVENT LOG

On the main screen hold and press  key to enter into menu page and select **Event log**, and then press  key again, the screen will show the event log interface as follow:

After enter into the “Event Log” interface, press  /  to view records.	
Action Event 10/99 S1Genset Start S1 Inactive S2 Inactive 2014-09-12 16:57:26	Alarm type, number and total count. Event Log; S1Power supply status; S2 Power supply status; Date and time;
Press  to view the detailed record information; press it again to exit the current record.	
Action Event 10/99 S1 Genset Start S1 Inactive S2 Normal 2014-09-12 16:57:26	Alarm type, number and total count. Event Log; S1Power supply status; S2 Power supply status; Date and time;
Press  /  to view the detailed record information; press it again to exit the current record.	
Action Event 10/99 S1 Genset Start U1LN 0 0 0V U2LN 220 221 219V F1 0.00Hz F2 50.00Hz	Alarm type, number and total count. Event Log; S1 Phase Voltage; S2 Phase Voltage; S1 Frequency, S2 Frequency;

Event log includes: event log type, event log, S1 power supply, S2 power supply, S1 3-phase voltage, S2 3-phase voltage, S1 frequency, S2 frequency and the record date and time.

Event log type includes: Action Event, Warn Event and Fault Event. All fault event actions are fault alarm while all warn event actions are warn alarm.

Table 17 - Action events

No.	Action Events	Description
1	Closing Main S1	Record when the main S1 close relay activated.
2	Closing Main S2	Record when the main S2 close relay activated.
3	Opening Main Switch	Record when the open relay (main S1 or main S2) activated.
4	Closing Bypass S1	Record when the bypass S1 close relay activated.
5	Closing Bypass S2	Record when the bypass S2 close relay activated.
6	Opening Bypass Switch	Record when the open relay (bypass S1 or bypass S2) activated.
7	Genset Start	Record when the genset start signals output.
8	S1 Genset Start	Record when the S1 genset start signals output.
9	S2 Genset Start	Record when the S2 genset start signals output.
10	Genset Stop	Record when the genset start signal deactivated.
11	S1 Genset Stop	Record when the S1 genset start signal deactivated.
12	S2 Genset Stop	Record when the S2 genset start signal deactivated.
13	Auto Mode	Record when the genset mode transferred to Auto Mode.
14	Manual Mode	Record when the genset mode transferred to Manual Mode.

10 ATS OPERATION

10.1 MANUAL OPERATION

Manual mode is selected by pressing the  button; a LED besides the button will illuminate to confirm the operation.

In manual mode, users can control the switch manually by pressing the buttons on the panel.

MTSE: bypass switch can be transferred only by manual operation of the bypass switch, bypass  button is inactive.

RTSE: main/bypass switch can be controlled by the controller. In the following conditions can transfer switch by pressing buttons on the panel.

Table 18 –Manual Operation for Remote Control Dual Bypass Switch

Switch	Bypass Switch Locked			Bypass Switch Unlocked		
	Main Switch In Work	Main Switch In Test	Main Switch In Isolation	Main Switch In Work	Main Switch In Test	Main Switch In Isolation
Main Switch	Operation	Operation	Non-operation	Non-operation	Non-operation	Non-operation
Bypass Switch	Non-operation	Non-operation	Non-operation	Operational	Operation	Non-operation

Mutual Backup Bypass Switch: Main switch and bypass switch are mutual standby, which can be used as main/standby respectively.

Table 19 – Dual Bypass Mutual Backup Switch

Manual Close/Open	Main Switch Unlocked, Bypass Switch Locked			Main Switch Locked, Bypass Switch Unlocked		
	Main Switch In Work	Main Switch In Test	Main Switch In Isolation	Main Switch In Work	Main Switch In Test	Main Switch In Isolation
	Bypass Switch In Work	▲	▲		■	■
Bypass Switch In Test	▲	▲		■	■	■
Bypass Switch In Isolation	▲	▲				

▲ Manual operation main switch close/open ■ Manual operation bypass switch close/open

For the single bypass system, only S1 close/open can be operated, and S2 close/open cannot be operated, corresponding S2 C/O button is inactive.

10.2 AUTOMATIC OPERATION

Auto mode is selected by pressing the  button; a LED besides the button will illuminate to confirm the operation. The controller will select S1 power or S2 power according to the preset “master set” and control the genset to start according to the mains status or other start conditions.

11 ATS POWER SUPPLY

Switch Power Type can be set as DC Power or AC Power. If DC Power is selected, then the switch can be transferred at any time (even when both S1 and S2 are outage). If AC Power is selected, whether the power is normal or not should be judged according to the ATS power setting and AC power voltage.

The power of ATS is supplied by controller, as long as one power is normal, this can ensure ATS voltage power supply normally and can be transferred properly.

Users should select power supply voltage (phase voltage or line voltage) based on ATS type. If choose phase voltage, connect the phase voltage of S1 and S2 (e.g. A phase) to normally close (Pin15) and normally open (Pin13) contact of auxiliary output 1; connect N phase of S1 and S2 to normally close (Pin18) and normally open (Pin16) contact of auxiliary output 2. And then connect the common output of auxiliary output 1 and auxiliary output 2 to ATS power supplies. Enter into the parameter setting interface, set the configurable output 1 as "ATS power L1" while set the configurable output 2 as "ATS power N". If the ATS power supplied by Line Voltage, same procedures as above but change phase N to phase voltage and the auxiliary output 2 should be configured according to the set. Wiring diagrams are shown

as following:

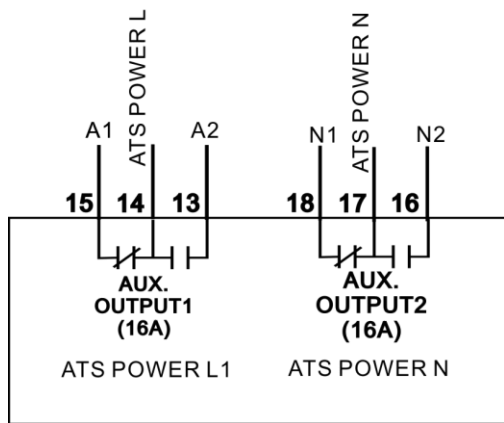

ATS phase voltage power supply

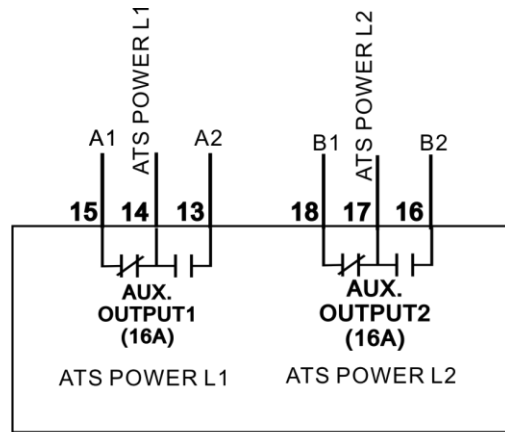

ATS line voltage power supply

Note: Normally Close (N/C) input voltage must come from S1 voltage.

Note: ATS Close/Open relay will active only when the ATS power is normal. If ATS Power output port is not configured, then the ATS power is supplied by L1-N phase (system default).

12 COMMUNICATION CONFIGURATION

HAT780 controller equips with RS485 serial port which enable the connection of LAN. It uses Modbus protocol via PC or system software, it can also be applicable to dual power switching management to factories, telecom, industrial and civil buildings, which achieves “remote control, remote measuring, remote communication” functions.

More information of Communication Protocol, please refer to “HAT780 Communication Protocol”.

Communication parameters:

Module address	1 (range: 1-254)
Baud rate	9600 bps (2400/4800/9600/19200bps)
Data bit	8-bit
Parity bit	None
Stop bit	2-bit (1-bit or 2-bit)

13 DESCRIPTION OF CONNECTING TERMINALS

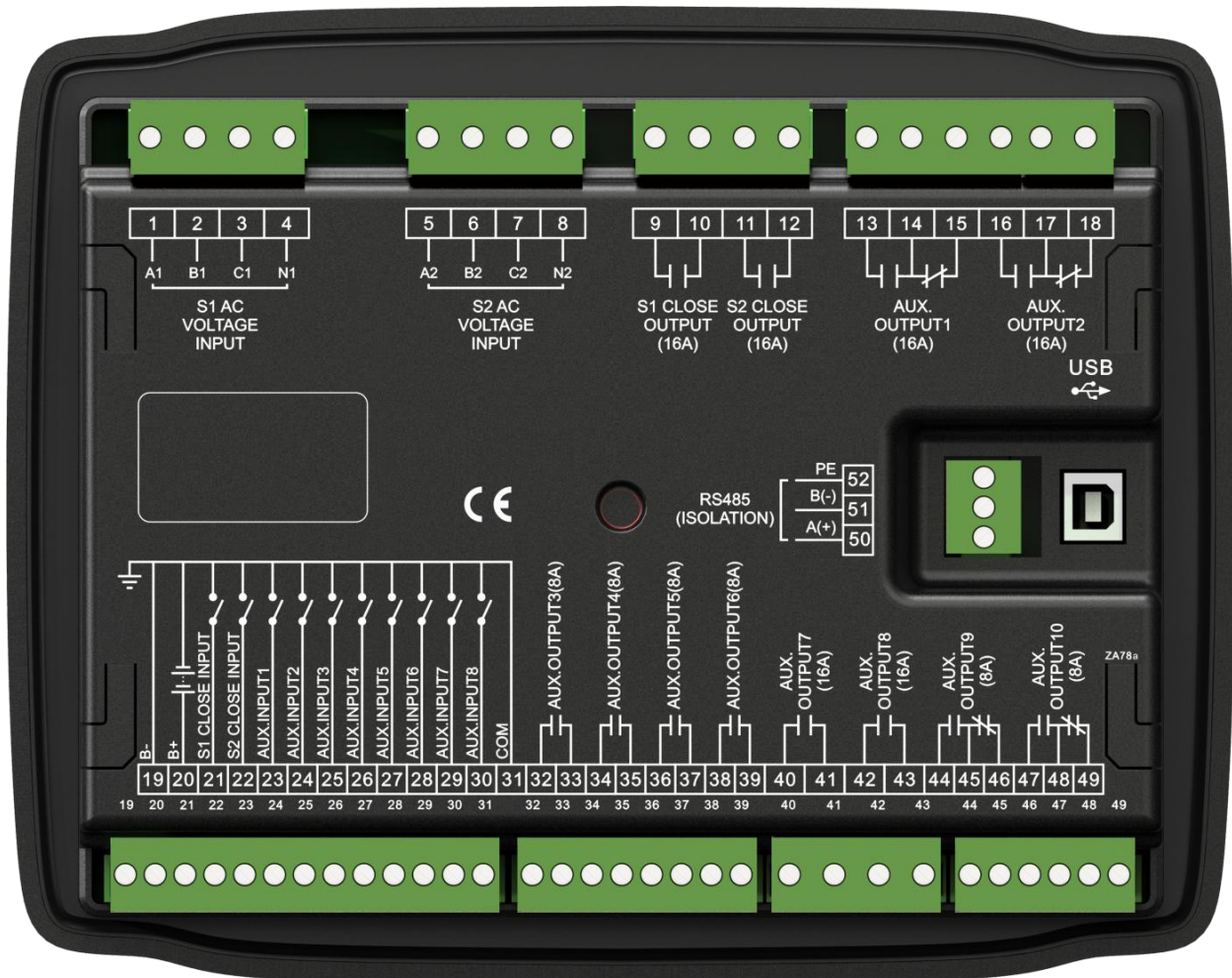

Fig.2 – Controller Rear Panel

Table 20 – Input/Output Ports Function Description

No.	Items	Description		Remark
1	A1	S1 AC System 3P4W voltage input		For single phase, only connect A1, N1
2	B1			
3	C1			
4	N1			
5	A2	S2 AC System 3P4W voltage input		For single phase, only connect A2, N2
6	B2			
7	C2			
8	N2			
9	S1 Close Output	Volts free relay output, normally open		Capacity AC250V16A
10				
11	S2 Close Output	Volts free relay output, normally open		Capacity AC250V16A
12				
13	Aux. Output 1	Normally Open	Default as ATS power L1 output	Volts free relay contact output Capacity AC250V16A
14		Common Port		
15		Normally Close		
16	Aux. Output 2	Normally Open	Default as ATS power N output	Volts free relay output Capacity AC250V16A
17		Common Port		
18		Normally Close		
19	B-	Connected with negative of starter battery.		Ground terminal
20	B+	Connected with positive of starter battery.		DC(8-35)V; Power supplied by controller.
21	S1 Close Input	Detect the S1 ATS closing status. Volts free contact input.		Ground connected is active.
22	S2 Close Input	Detect the S2 ATS closing status. Volts free contact input.		Ground connected is active.
23	Aux. Input 1	User-defined. Input port function		Ground connected is active.
24	Aux. Input 2			
25	Aux. Input 3			
26	Aux. Input 4			
27	Aux. Input 5			
28	Aux. Input 6			
29	Aux. Input 7			
30	Aux. Input 8			
31	COM	Input earthed common port		Internal has been connected with ground terminal B-.
32	Aux. Output 3	Volts free; Relay contact; Normally Open output. Default as S1 Open Control.		Capacity: AC250V8A
33				
34	Aux. Output 4	Volts free; Relay contact; Normally		Capacity: AC250V8A



No.	Items	Description	Remark
35		Open output. Default as S2 Open Control.	
36	Aux. Output 5	Volts free; Relay contact; Normally Open output. Default as S1 Bypass Open Control.	Capacity: AC250V8A
40			
38	Aux. Output 6	V Volts free; Relay contact; Normally Open output. Default as S2 Bypass Open Control.	Capacity: AC250V8A
39			
40	Aux. Output 7	Volts free; Relay contact; Normally Open output. Default as S1 Bypass Close Control.	Capacity: AC250V8A
41			
42	Aux. Output 8	Volts free; Relay contact; Normally Open output. Default as S2 Bypass Close Control.	Capacity: AC250V8A
43			
44	Aux. Output 9	Normally Open	Volts free relay output Capacity AC250V8A
45		Common Port	
46		Normally Close	
47	Aux. Output 10	Normally Open	Volts free relay output Capacity AC250V8A
48		Common Port	
49		Normally Close	
50	RS485 A(+)	RS485 Communication Port	120Ω impedance matched resistance should be connected according to the different situation. PE is external ground terminal
51	RS485 B(-)		
52	RS485 PE		
USB	USB COM Port	Used for PC program updating and parameters set.	

14 TYPICAL WIRING DIAGRAM

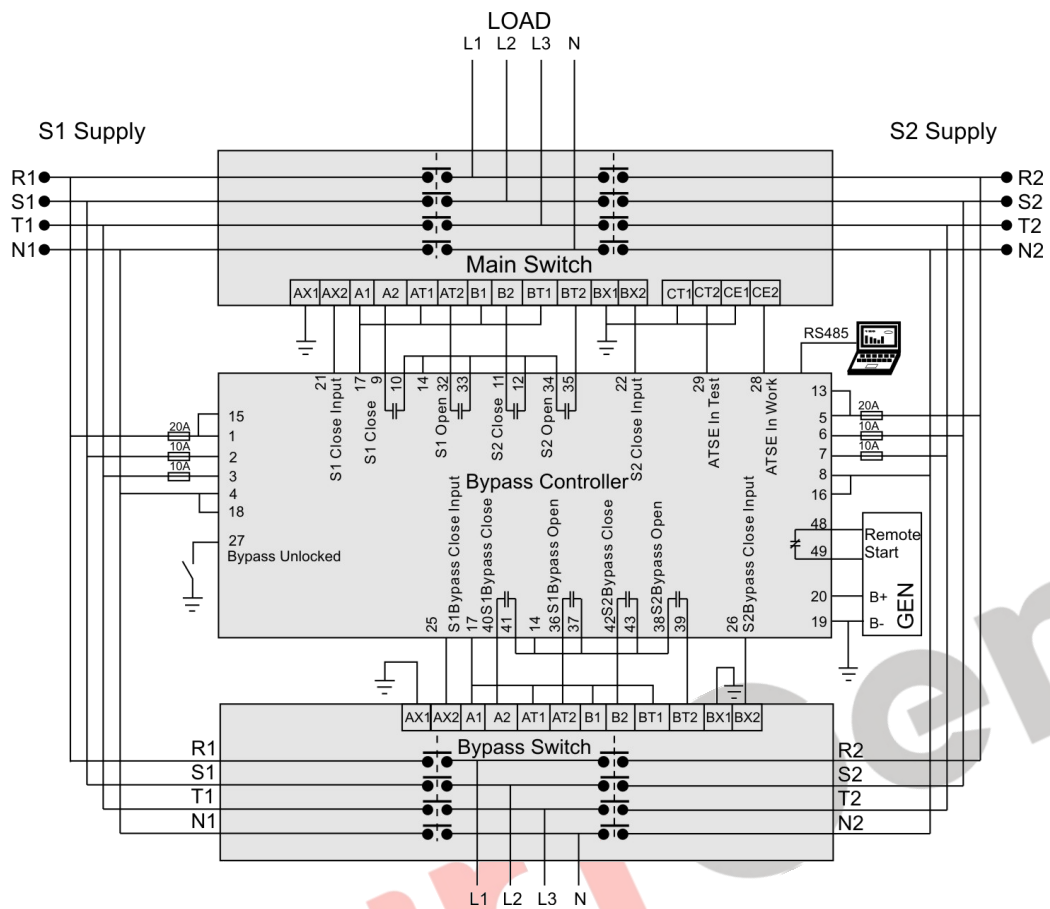

Fig.3 – Dual Bypass Remote Control Application Diagram

A1, A2: S1 close coil; AT1, AT2: S1 open coil; AX1, AX2: S1 close auxiliary status;
 B1, B2: S2 close coil; BT1, BT2: S2 open coil; BX1, BX2: S2 close auxiliary status;
 CT1, CT2: Switch is in test position; CE1, CE2: Switch is in work position.

Table 21 – Dual Bypass Remote Control Parameters Setting

Partial Parameters Setting	
Bypass Function Type	Dual Bypass DBTSE
Bypass Switch Type	Remote Bypass Switch RTSE
Aux. Output 1	ATS Power L1
Aux. Output 2	ATS Power N
Aux. Output 3	S1 Open Control
Aux. Output 4	S1 Open Control
Aux. Output 5	S1 Bypass Open Output
Aux. Output 6	S2 Bypass Open Output
Aux. Output 7	S1 Bypass Close Output
Aux. Output 8	S2 Bypass Close Output
Aux. Output 9	Parallel Power Supply
Aux. Output 10	Genset Start
Aux. Input 3	S1 Bypass Close Input
Aux. Input 4	S2 Bypass Close Input
Aux. Input 5	Bypass Unlocked
Aux. Input 6	ATSE In Test
Aux. Input 7	ATSE In Work

15 INSTALLATION

Controller is panel built-in design; it is fixed by clips when installed.

Unit: mm

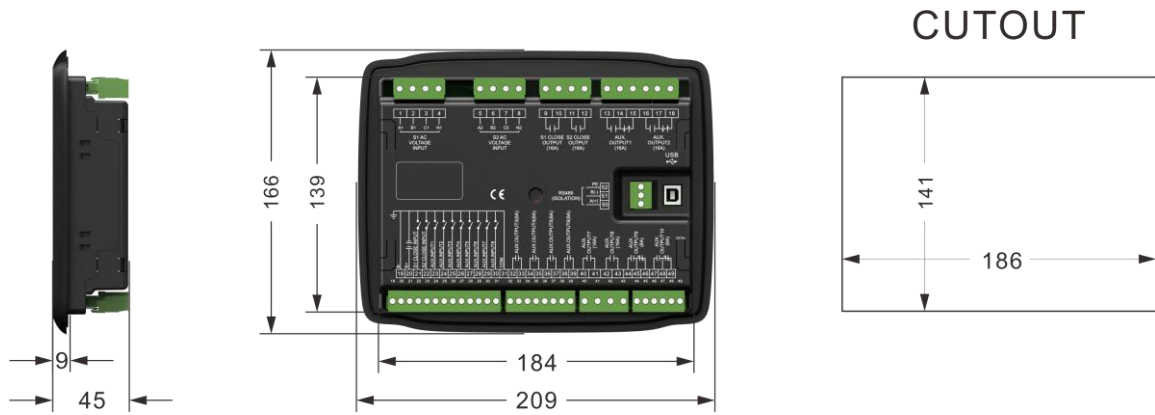

Fig.4 – Overall & Cutout Dimensions

SmartGen

16 FAULT FINDING

Table 22 - Troubleshooting

Symptoms	Possible Solutions
Controller no response with power.	<p>Check DC voltage.</p> <p>Check DC fuse.</p> <p>Check AC Power supply.</p>
RS485 communication is abnormal	<p>Check RS485's connections of A and B is reverse connect or not.</p> <p>Check RS485 transfer model whether damage or not.</p> <p>Check the module address.</p> <p>If above methods can't solve the problem, parallel connection 120Ω resistor between RS485 A terminal and B terminal is recommended.</p>
Auxiliary Output Error	<p>Check auxiliary output connections, pay attention to normally open contact and normally close contact.</p> <p>Check the output settings in parameters settings.</p>
Auxiliary Input Error	<p>Ensure that the auxiliary input is soundly connected to GND when it's active, while hung up when it is inactive.</p> <p>(▲Note: The input port will be possibly destroyed when connected with voltage)</p> <p>Check the input settings in parameters settings.</p>
Genset running while ATS not transfer	<p>Check ATS.</p> <p>Check the connection wirings between the Controller and the ATS.</p> <p>Ensure that the switch type is same as the setting.</p> <p>Check ATS power and its connection.</p>
Genset Start Abnormal	<p>Check system type setting.</p> <p>Check the output settings in parameters settings.</p> <p>Check all Start/Stop settings.</p>