

SmartGen

MAKING CONTROL SMARTER

HGM1790N GENSET CONTROLLER USER MANUAL



郑州众智科技股份有限公司
SMARTGEN(ZHENGZHOU)TECHNOLOGY CO.,LTD.

All rights reserved. No part of this publication may be reproduced in any material form (including photocopying or storing in any medium by electronic means or other) without the written permission of the copyright holder.

SmartGen reserves the right to change the contents of this document without prior notice.

Table 1 Software Version

| Date | Version | Note |
|------------|---------|--|
| 2016-10-11 | 1.0 | Original release. |
| 2017-10-09 | 1.1 | 1) Changed "Stop Output Relay" and "Idle Control Relay" into "Aux. Output"; Changed rare panel description and typical application description; Added "Aux. Output 1" and "Aux. Output 2" configuration options. 2) Modified storage temperature. |
| 2020-09-30 | 1.2 | Modified the incorrect word spell "Frequency" of 4.4 "LCD ICONS". |
| 2021-03-18 | 1.3 | Modified the error in table 7 and other translation problems. |
| 2021-09-30 | 1.4 | Added Outputs Contents "7: Rated Speed Output 8: Over Speed Output" in Table 8. |
| 2022-06-10 | 1.5 | Updated the logo of SmartGen. |
| 2024-03-18 | 1.6 | Added Outputs Contents "9: Start Output" in Table 8. |
| | | |
| | | |

CONTENT

| | |
|---|----|
| 1. OVERVIEW..... | 4 |
| 2. PERFORMANCE AND CHARACTERISTICS | 4 |
| 3. SPECIFICATION | 6 |
| 4. OPERATION..... | 7 |
| 4.1. FRONT PANEL DESCRIPTION..... | 7 |
| 4.2. INDICATOR DESCRIPTION..... | 7 |
| 4.3. PANEL KEYS | 8 |
| 4.4. LCD ICONS..... | 8 |
| 4.5. DISPLAY DESCRIPTION | 9 |
| 4.6. AUTO START/STOP OPERATION | 10 |
| 4.7. MANUAL START/STOP OPERATION..... | 11 |
| 5. PROTECTION | 11 |
| 6. WIRING CONNECTION | 13 |
| 7. PARAMETER RANGE AND DEFINITION | 15 |
| 7.1 PARAMETERS CONTENTS AND RANGE..... | 15 |
| 7.2 DEFINABLE CONTENTS OF RELAY OUTPUTS..... | 19 |
| 7.3 DEFINABLE CONTENTS OF DIGITAL INPUTS..... | 19 |
| 7.4 SENSOR SELECTION..... | 20 |
| 7.5 CONDITIONS OF CRANK DISCONNECT SELECTION..... | 21 |
| 8. CONTROLLER FUNCTION SETTING..... | 22 |
| 8.1. PARAMETER SETTING..... | 22 |
| 8.2. LCD CONTRAST ADJUSTMENT..... | 23 |
| 8.3. GENERATOR FLYWHEEL TEETH AUTOMATIC ADJUSTMENT..... | 23 |
| 9. SENSOR SETTINGS | 24 |
| 10. COMMISSIONING | 25 |
| 11. TYPICAL APPLICATION | 26 |
| 12. INSTALLATION | 27 |
| 12.1. FIXING CLIPS..... | 27 |
| 12.2. OVERALL DIMENSION..... | 27 |
| 13. FAULT FINDING | 29 |

1. OVERVIEW

HGM1790N genset controller is suit for single unit automation and monitoring control (also can be used for pumping unit). It can realize manual start/stop of genset, and it can also automatically start/stop genset by remote start signal. HGM1790N controller can supervise and protect genset operation by gathering and analyzing genset data like generate voltage, current, water temperature, oil pressure and so on, and it can indicate fault conditions and do maintenance as soon as possible. The graphical LCD and touch-button operation make it clear and intuitive. Moreover, parameter threshold and delay value can be adjusted via front panel or USB port (communicated with PC software).

2. PERFORMANCE AND CHARACTERISTICS

- Graphical LCD display (with backlight), LED indicator, touch-buttons operation;
- Hard screen acrylic material is used to protect screen.
- Silicone panel and buttons are adopted to increase high and low temperature adaption ability;
- Power supply range DC (8~35)V, compatible with 12V or 24V starting batteries;
- Generator single phase voltage, current, frequency, power and load percentage parameters are measured and displayed:

| | | | |
|-------------------|----|---------------------|----|
| Generator Voltage | V | Generator Frequency | Hz |
| Generator Power | kW | Generator Current | A |
| Load Percentage | % | | |

- Precision measured and displayed parameters of engine:

| | | | |
|-----------------|-----|--------------------|-----------------------|
| Oil Pressure | kPa | Temperature | °C |
| Fuel Level | % | Total Running Time | H (max. 199999 hours) |
| Battery Voltage | V | Engine Speed | RPM |

Accumulated Start Times (max. 199999 times, displayed on PC)

- With genset fault protection and display functions.
- 3 working modes: manual, auto, stop;
- Compatible with multiple temperature, pressure, fuel level sensors, which can be user-defined and used directly; temperature sensors, pressure sensors can be used in parallel with annunciator, providing analog quantity and increasing protection level at the same time;
- Multiple crank disconnect conditions to select (engine speed sensor, oil pressure, generator frequency);
- 1 configurable input port which can be set as digital input or liquid level sensor;

- 2 fixed relay outputs (fuel relay, start relay);
- 3 configurable output ports which can be set as common alarm output, preheat output or idle control output;
- Parameters can be set and modified by users and saved in internal FLASH storage, which means that they will not be lost in case of power off. Most parameters of the controller can be modified using the front panel and all parameters can be adjusted by PC software via type-B USB port;
- Digital regulation of all parameters - instead of analog regulation using conventional potentiometer, therefore, higher reliability and stability;
- Modular design, self-extinguishing ABS plastic enclosure and embedded installation way; small size and compact structure with easy mounting

SmartGen

3. SPECIFICATION

Table 2 Technical Parameters

| Item | Content |
|----------------------------|--|
| Working Voltage | DC8. 0V to 35. 0V, Continuous Power Supply |
| Power Consumption | <1.2W (Standby mode: ≤0.5W) |
| Alternator Voltage Input | AC 15V ~ AC 360 V (ph-N) |
| Alternator Frequency | 50Hz/60Hz |
| Speed Sensor Voltage | 1.0V to 24V (RMS) |
| Speed Sensor Frequency | Max. 10, 000Hz |
| Start Relay Output | 1Amp DC28V DC B+ power supply |
| Fuel Relay Output | 1Amp DC28V DC B+ power supply |
| Aux. Output1 | 1Amp DC28V DC B+ power supply |
| Aux. Output2 | 1Amp DC28V DC B+ power supply |
| Aux. Output3 | 1Amp DC28V DC B+ power supply |
| Programmable Digital Input | Active when connected to B- |
| Case Dimensions | 95mm x 86mm x 46.5mm |
| Panel Cutout | 78mm x 66mm |
| CT Secondary Current | Rated: 5A |
| Working Temperature | (-25~+70)°C |
| Working Humidity | (20~93)%RH |
| Storage Temperature | (-25~+70)°C |
| Protection Level | IP55: When waterproof rubber gasket installed between the controller and panel fascia. |
| Insulation Intensity | Attach AC2.2kV voltage between AC high voltage terminal and low voltage terminal (leak current below 3mA in 1 minute). |
| Weight | 0.18kg |

4. OPERATION

4.1. FRONT PANEL DESCRIPTION



Fig.1 HGM1790N Front Panel Indication

4.2. INDICATOR DESCRIPTION

Stop status indicator light: genset in stop mode.





Auto status indicator light: genset in auto mode.

Manual start indicator light: genset in manual mode.

Alarm indicator light: blink slowly (1 time/s) when warn alarm occurred; blink fast (5 times/s) when shutdown alarm occurred.















4.3. PANEL KEYS

Table 3 Key Descriptions

| Key | Definition | Description |
|---|----------------|--|
|  | Stop/Reset | In auto/manual mode, press this button will shutdown the genset; Reset shutdown alarms when genset in alarm status; Indicator lights and LCD icons status can be tested when press this button for over 3s in stop mode; Stop immediately if press this button during stop process; Quick exist parameter setting menu if press this button. |
|  | Auto/Increase | Pressing this button will place the module into its auto mode, and genset is controlled by remote start signals; In settings menu moves cursor up and increases the set value. |
|  | Start/Decrease | Pressing this button will start genset. In settings menu moves cursor down and decreases the set value. |
|  | Page Down | Using this button you can scroll pages of the LCD monitor; Enter settings menu if hold and press over 2s; Move cursor and confirm setting information in parameter setting menu. |

4.4. LCD ICONS

Table 4 LCD Icons

| Icon | Definition | Icon | Definition |
|---|---|------------|-------------------------------------|
|  | Genset Start Indication | FL | Fuel Level Indication |
|  | Boot time is counting (reaching crank disconnect condition) | L1 | Generator Voltage Indication |
|  | Emergency Stop Alarm | DC | Battery Voltage Indication |
|  | Over Speed/Over Frequency Alarm | kPa | Oil Pressure Unit |
|  | Under Speed/Under Frequency Alarm | A | Current With Load Unit |
|  | High Temp. Alarm | H | Hours Count |
|  | Low Fuel Level | Hz | Frequency Unit |
|  | Auxiliary Alarm | °C | Temperature Unit |
|  | Low Oil Pressure | rpm | Speed Unit (revolutions per minute) |
|  | Fail to Start | kW | Active Power Unit |
|  | Fail to Stop | V | Voltage Unit |
|  | Voltage Abnormal | % | Percentage |
|  | Over Voltage | | |
|  | Under Voltage | | |
|  | Over Current With Load | | |

4.5. DISPLAY DESCRIPTION

Generator: phase voltage L1, frequency F



Load percentage



Fuel level, total running time



Parameter setting



Load: active power, current

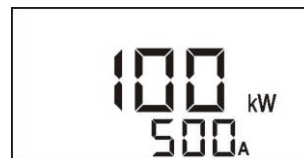

Oil pressure, temperature



Battery voltage, engine speed



▲NOTE:

- 1) When active power is "----", which means active power is negative, please check voltage and current connection.
- 2) When pressure, temperature and liquid level sensors are not displayed, which means not used; when displayed "OFF" means sensors are open circuit.
- 3) When total running time is lower than 20000 hours, value before the decimal point means running hours and value after the decimal point means 1/10 hour.

4.6. AUTO START/STOP OPERATION

Auto mode is selected by pressing ; a LED besides the button will illuminate to confirm the operation.

Automatic Start Sequence:

- 1) When "Remote Start" is active (6 terminal connected with B-), "Start Delay" timer is initiated;
- 2) When start delay is over, preheat relay energizes (if configured), "Preheat Delay" starts to count.
- 3) After the preheat delay, the Fuel Relay (if configured) is energized, and then one second later, the Start Relay is engaged. If the genset fails to fire during "Cranking Time", then the fuel relay and start relay stop to output; "Crank Rest Time" begins and wait for the next crank attempt.
- 4) Should this start sequence continue beyond the set number of attempts, the start sequence will be terminated,  will be displayed on LCD means Fail to Start and meanwhile, alarm indicator light is blinking.
- 5) In case of successful crank attempt, the "Safety On" timer is activated, Low Oil Pressure, High Temperature and other alarms are inactive during the period. As soon as this delay is over, "Start Idle" delay is initiated (if configured).
- 6) During "Start Idle" delay, under speed, under frequency, under voltage alarms are inhibited. When this delay is over, "Warming up" delay is initiated (if configured).
- 7) When "Warming up" delay is over, genset starts normal running; if generator voltage or frequency is abnormal, shutdown alarm signals will be sent by the controller.



Automatic Stop Sequence,

- 1) When the "Remote Start" signal is removed, "Stop Delay" is initiated.
- 2) Once this "Stop Delay" has expired, the "Cooling Delay" is then initiated.
- 3) During "Stop Idle" Delay (if configured), idle relay is energized.
- 4) "ETS Solenoid Hold" begins, ETS relay is energized while fuel relay is de-energized.
- 5) "Fail to Stop Delay" begins, complete stop is detected automatically.
- 6) Generator is placed into its standby mode after its "After stop" delay. Otherwise, fail to stop alarm is initiated. (LCD display )

NOTE:





- a) When press stop button in auto start status, genset will stop and enter into stop mode simultaneously.
- b) In process of crank rest delay, preheat and ETS functions are energized when fuel output is de-energized and crank rest time countdown is less than 7s. After crank rest delay, ETS output is de-energized, fuel relay starts output, and preheat relay output is off before crank.









4.7. MANUAL START/STOP OPERATION

- 1) **MANUAL START:** Press  button to start the genset (No.2~7 of **Automatic Start Sequence** for detail procedures). With high temperature, low oil pressure, over speed and abnormal voltage during generator running, controller can protect genset to stop quickly.
- 2) **MANUAL STOP:** Press  can shut down the running genset. (Please refer to No.2~6 of **Automatic Stop Sequence** for detail procedures).

5. PROTECTION

Table 5 Controller Alarms

| Icons | Alarms | Type | Triggering Condition |
|---|---|------------|--|
|  | Emergency Shut Alarm | Shut Alarm | Controller sent alarms when detected emergency shutdown alarms. |
|  | Over Speed Shut | Shut Alarm | Controller sent alarms when genset speed is higher than over speed threshold and lasts for over 2s. |
| | Over Frequency Shut | Shut Alarm | Controller sent alarms when generator frequency is higher than over frequency threshold and lasts for over 2s. |
|  | Under Speed Shut | Shut Alarm | Detection after warming up delay, controller sent alarms when speed is lower than under speed threshold and lasts for over 10s. |
| | Under Frequency Shut | Shut Alarm | Detection when genset is normal running, controller sent alarms once genset frequency fell below under frequency threshold and lasts for over 10s. |
|  | High Temp. Shut | Shut Alarm | Detection after safe running delay, controller sent alarms once genset temperature is higher than over temp. threshold and lasts for over 3s. |
| | High Temp. Input Shut | Shut Alarm | Detection after safe running delay, controller sent alarms when high temperature input is active. |
| | Temp. Sensor Open/Short Circuit Shut | Shut Alarm | Detection after safe running delay, controller sent alarms when temperature sensor resistance value is above 6000Ω or under 5Ω. |
|  | Low Oil Pressure Shut | Shut Alarm | Detection after safe running delay, controller sent alarms when genset oil temperature is lower than low oil pressure threshold and lasts for over 2s. |
| | Low Oil Pressure Input Shut | Shut Alarm | Detection after safe running delay, controller sent alarms when low oil pressure input is active. |
| | Oil Pressure Sensor Open/Short Circuit Shut | Shut Alarm | Detection after safe running delay, controller sent alarms when oil pressure sensor resistance value is above 6000Ω or under 5Ω. |

| Icons | Alarms | Type | Triggering Condition |
|---|---|------------|--|
|  | Gen Over Current Warn | Warn Alarm | Controller sent alarms when generator current is higher than the preset value and over current action is selected as "Warn". |
| | Gen Over Current Shut | Shut Alarm | Controller sent alarms when generator current is higher than the preset value and lasts for over the delay value (over current action is selected as "Shutdown"). |
| | Gen Over Current Cooling Shut | Shut Alarm | Controller sent alarms when generator current is higher than the preset value and lasts for over than delay value (over current action is selected as "Cooling Shutdown"). |
|  | Gen Over Volt Shut | Shut Alarm | Detection after safe running delay, controller sent alarms when generator voltage is higher than over than voltage threshold and lasts for over than voltage abnormal delay value. |
|  | Gen Low Volt Shut | Shut Alarm | Detection after safe running delay, controller sent alarms when generator voltage is lower than under voltage threshold and lasts for over than voltage abnormal delay value. |
|  | Fail to Start | Shut Alarm | Controller Sent alarms when genset fail to start in preset attempts. |
|  | Auxiliary Shut Alarm Input | Shut Alarm | Controller sent alarms when auxiliary input port, which is configured as "auxiliary shutdown alarm input", is active. |
|  | Low Fuel Level Warn | Warn Alarm | Controller sent alarms when fuel level is lower than low fuel level threshold and lasts for over 10s. |
| | Low Fuel Level Input Warn | Warn Alarm | Controller sent alarms when low fuel level input is active. |
| | Fuel Level Sensor Open/Short Circuit Warn | Warn Alarm | Controller sent alarms when Fuel level sensor resistance value is above 6000Ω or under 5Ω. |
|  | Fail to Stop | Warn Alarm | Controller sent alarms when genset fail to stop in stop duration. |
|  | Low Battery Volt Warn | Warn Alarm | Controller sent alarms when battery voltage is lower than under voltage threshold and lasts for over 20s. |
| | High Battery Volt Warn | Warn Alarm | Controller sent alarms when battery voltage is higher than over voltage threshold and lasts for over 20s. |

6. WIRING CONNECTION

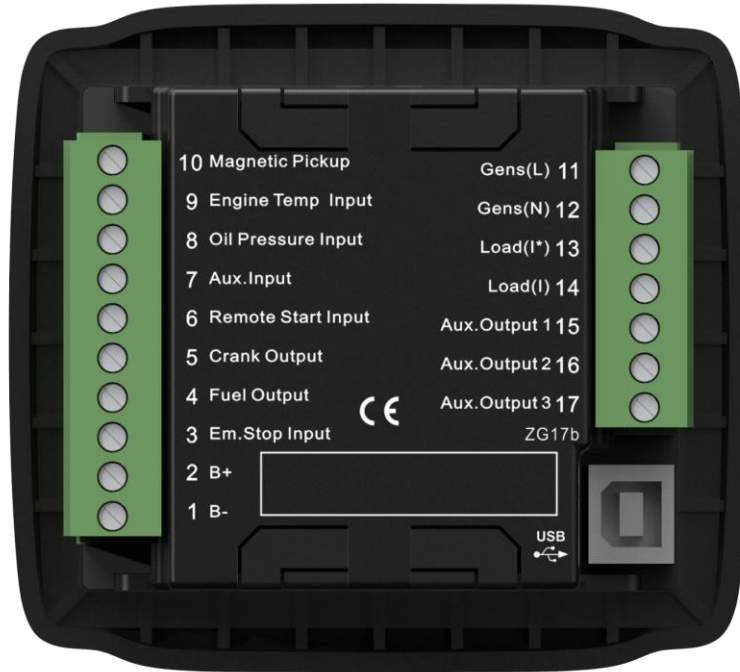

Fig.2 Controller Back Panel

Table 6 Terminals Description

| No. | Function | Cable Size | Remarks |
|-----|----------------------|--------------------|---|
| 1 | DC Voltage Input B- | 1.5mm ² | Connect to negative of starting battery |
| 2 | DC Voltage Input B+ | 1.5mm ² | Connected to positive of starting battery. If wire length is over 30m, better to double wires in parallel. Max. 20A fuse is recommended. |
| 3 | Emergency Stop Input | 1.0mm ² | B+ voltage input is active, and connected to emergency stop normal closed button. |
| 4 | Fuel Output | 1.0mm ² | B+ is supplied by No.3 point, rated 1A. |
| 5 | Crank Output | 1.0mm ² | B+ is supplied by No.3 point, rated 1A. |
| 6 | Remote Start Input | 1.0mm ² | Ground connected is active (B-) |
| 7 | Aux. Input | 1.0mm ² | Ground connected is active (B-) if it is configured as digital input. Connect to low fuel level coil or fuel level resistor type sensor if it is configured as level sensor. |
| 8 | Oil Pressure Input | 1.0mm ² | Connect to low oil pressure coil or resistor type sensor. |
| 9 | Engine Temp. Input | 1.0mm ² | Connect to high water/cylinder temp. coil or temperature resistor type sensor. |
| 10 | Magnetic Pickup | 0.5mm ² | Connect to speed sensor, and shielded wire is recommended. The other end of speed sensor is connected to B-. |
| 11 | Gen Volt Monitoring | 1.0mm ² | Connect to generator voltage output port. (2A fuse is |

SmartGen

| No. | Function | Cable Size | Remarks |
|-----|----------------------------|---------------------|---|
| 12 | Input | 1.0mm ² | recommended) |
| 13 | Load Current (Inlet Loop) | 1.5 mm ² | Connect to secondary coil of current transformer. (Rated 5A) |
| 14 | Load Current (Outlet Loop) | 1.5 mm ² | |
| 15 | Aux. Output 1 | 1.0 mm ² | B+ is supplied by No.2 point, rated 1A. |
| 16 | Aux. Output 2 | 1.0 mm ² | B+ is supplied by No.2 point, rated 1A. |
| 17 | Aux. Output 3 | 1.0 mm ² | B+ is supplied by No.2 point, rated 1A. |

▲NOTE: Type-B USB port, which can be connected with PC software, is applied for parameter configuration and data monitoring.

SmartGen

7. PARAMETER RANGE AND DEFINITION

7.1 PARAMETERS CONTENTS AND RANGE

Table 7 Parameter Setting Contents and Range

| No. | Parameter | Range | Default Value | Description |
|-----|--------------------|--------------|---------------|--|
| P00 | Start Delay | (0-3600)s | 1 | Time from remote start signal is active to start genset. |
| P01 | Stop Delay | (0-3600)s | 1 | Time from remote start signal is deactivated to stop genset. |
| P02 | Start Attempts | (1-10) times | 3 | The maximum number of crank attempts. If none of them is successful, the controller will initiate fail to start alarm. |
| P03 | Preheat Time | (0-300)s | 0 | Time of pre-powering heat plug before starter is powered up. |
| P04 | Cranking Time | (3-60)s | 8 | The time of powering up the starter for every crank attempt |
| P05 | Crank Rest Time | (3-60)s | 10 | The waiting time before second power up when engine start fail. |
| P06 | Safety On Delay | (1-60)s | 10 | Alarms for low oil pressure, high temperature, under speed, under frequency and under voltage are inactive. |
| P07 | Start Idle Time | (0-3600)s | 0 | Idle running time of genset when starting. |
| P08 | Warming Up Time | (0-3600)s | 10 | Warming time between genset switch on and normal running. |
| P09 | Cooling Time | (3-3600)s | 10 | Radiating time before genset stop, after it unloads. |
| P10 | Stop Idle Time | (0-3600)s | 0 | Idle running time when genset stop. |
| P11 | ETS Solenoid Hold | (0-120)s | 20 | The time of powering up the electromagnet during stop procedure. |
| P12 | Fail to Stop Delay | (0-120)s | 0 | Time between ending of genset idle delay and stopped when "ETS output time" is set as 0; Time between ending of ETS hold delay and stopped when "ETS output time" is not 0. |
| P13 | Flywheel Teeth | (1-300) | 118 | Tooth number of the engine is for judging of crank disconnect conditions and inspecting of engine speed. See the installation instructions. |

| No. | Parameter | Range | Default Value | Description |
|-----|-------------------------|-------------|---------------|---|
| P14 | Generator Poles | (2-16) | 4 | Configuring numbers of generator poles. |
| P15 | Generator Abnormal Time | (0-20.0)s | 10.0 | Alarm delay for generator over and under voltage states. |
| P16 | Generator Over Voltage | (30-1000)V | 264 | When generator voltage exceeds this value and stays so for the time of "Generator Abnormal Time", it is regarded as over voltage and Generator Over Voltage shutdown alarm is initiated. If the voltage value is 1000V, over voltage signal is not initiated. |
| P17 | Generator Under Voltage | (30-1000)V | 196 | When detected voltage falls below this value and stays so for the time of "Generator Abnormal Time", it is regarded as under voltage and Generator Under Voltage shutdown alarm is initiated. If the voltage value is 30V, under voltage signal is not initiated. |
| P18 | Engine Under Speed | (0-6000)RPM | 1200 | When engine speed falls below this value and stays so for 10s, this is regarded as under speed and under speed alarm shutdown signal is sent. |
| P19 | Engine Over Speed | (0-6000)RPM | 1710 | When engine speed exceeds this value and stays so for 2s, this is regarded as over speed and over speed alarm shutdown signal is sent. |
| P20 | Under Frequency | (0-75.0)Hz | 45.0 | When generator frequency falls below this value and not 0, and stays so for 10s, it is regarded as under frequency and under frequency alarm shutdown is initiated. |
| P21 | Over Frequency | (0-75.0)Hz | 57.0 | When generator frequency exceeds this value and stays so for 2s, it is regarded as an over frequency and over frequency alarm shutdown is initiated. |
| P22 | High Temperature | (80-140)°C | 98 | When the temperature value of the external temperature sensor exceeds this threshold, high temperature signal is sent. Detection starts after safety |

| No. | Parameter | Range | Default Value | Description |
|-----|-------------------------|------------|---------------|---|
| | | | | delay and only concerns external temperature sensor which connected to the temperature sensor input port. If the set value is 140, high temperature signal will not be sent (this only concerns temperature sensor, not high temperature signal via config. input port). |
| P23 | Low Oil Pressure | (0-400)kPa | 103 | When the external pressure sensor value falls below this threshold, low oil pressure delay begins. Detection begins after safely on delay. If the set value is 0, low oil pressure signal is not sent (this only concerns pressure sensor and does not concern low oil pressure warning signal via configurable input port) |
| P24 | Low Liquid Level | (0-100)% | 10 | When the liquid level of the external sensor falls below this value and stays so for 10s, low liquid level signal is sent and warning without shutdown is initiated. |
| P25 | Battery Over Volts | (12-40)V | 33.0 | When battery voltage exceeds this value and stays so for 20s, Battery Over Volts signal is sent and warning without shutdown is initiated. |
| P26 | Battery Under Volts | (4-30)V | 8.0 | When battery voltage falls below this value and stays so for 20s, Battery Under Volts signal is sent and warning without shutdown is initiated. |
| P27 | CT Ratio | (5-6000)/5 | 500 | Current transformer ratio default as 500:5. |
| P28 | Full-load Current | (5-1900)A | 500 | It is the rated current of generator, which is apply for calculating over current with load. |
| P29 | Over Current Percentage | (50-130) | 120 | Over current delay starts when current with load is greater than value of full-load current multiply over current percentage. |
| P30 | Over Current | (0-3600)s | 60 | When current with load exceeds preset |

| No. | Parameter | Range | Default Value | Description |
|-----|-------------------------------|----------------|---------------|--|
| | Delay | | | value and stays so over delay time, over current alarm will be initiated. |
| P31 | Action | (0-2) | 0 | 0: Warn 1: Shutdown 2: Cooling and Shutdown |
| P32 | Aux. Output 3 | (0-9) | 1 | Default: Common Alarm |
| P33 | Digital Input | (0-8) | 4 | Default: Auxiliary shutdown; if the set value is 8, fuel level sensor type can be selected. |
| P34 | Digital Input Delay | (0-20.0)s | 2.0 | Active delay time for digital input ports |
| P35 | Power On Mode | (0-2) | 0 | 0: Stop 1: Manual 2: Auto |
| P36 | Password Set | (0-9999) | 0318 | |
| P37 | Crank Disconnect Condition | (0-6) | 1 | See table 11. Starter disconnection condition. There are 3 conditions of disconnecting starter with engine (speed, generator frequency and oil pressure). Aiming at to separate the start motor and engine as soon as possible. |
| P38 | Disconnect Engine Speed | (0-3000) RPM | 360 | When speed is higher than the set value, starter will be disconnected. |
| P39 | Disconnect Generator Freq | (10.0-30.0) Hz | 14.0 | When generator frequency higher than the set value, starter will be disconnected. |
| P40 | Disconnect Oil Pressure | (0-400) kPa | 200 | When generator oil pressure higher than the set value, starter will be disconnected and oil engine crank successfully. |
| P41 | AC System | (0-3) | 2 | 0: 3P4W 1: 2P3W 2: 1P2W 3: 3P3W It is used for calculating generator voltage and active power. |
| P42 | Temp. Sensor | (0-10) | 06 | SGD (120°C resistor type) |
| P43 | OP Sensor | (0-10) | 06 | SGD (10Bar resistor type) |
| P44 | Fuel Level Sensor | (0-7) | 0 | Not used. (If fuel level sensor is used, then the digital input port must be set as "8 Multiplex Level Sensor". |
| P45 | Disconnect Oil Pressure Delay | (0-20.0)s | 0.0s | When crank disconnect condition including oil pressure, and engine oil pressure and delay value are higher |

| No. | Parameter | Range | Default Value | Description |
|-----|---------------|-------|---------------|--|
| | | | | than set values, starter will be disconnected and oil engine crank successfully. |
| P46 | Aux. Output 1 | (0-9) | 3 | Default: Idle Speed Output |
| P47 | Aux. Output 2 | (0-9) | 2 | Default: ETS Output |

7.2 DEFINABLE CONTENTS OF RELAY OUTPUTS

Table 8 Definable Contents of Relay Outputs

| No. | Items | Description |
|-----|--------------------|---|
| 0 | Not Used | Output is not active. |
| 1 | Common Alarm | Includes all shutdown alarms and warning alarms. Warning alarms are not self-latching, while shutdown alarms are self-latching and will not disappear until they are reset. |
| 2 | Energize to Stop | Suitable for the genset with stop electromagnet. The electromagnet closes when stop idle is over. And opens when EST delay is over. |
| 3 | Idle Control | Used for machines that have idles. Closes during cranking, disconnects during warming up, closes during stop idle delay, disconnects after complete stop. |
| 4 | Preheat Control | It closes before starting and opens before starter is powered on. |
| 5 | Closing Gens | During normal operation of the generator, closes the breaker. |
| 6 | High Speed Output | Output when entering high speed warming up and disconnect after high speed cooling. |
| 7 | Rated Speed Output | Output when speed is normal. |
| 8 | Over Speed Output | Output when speed is over the set limit value. |
| 9 | Start Output | Output when genset is starting. |

7.3 DEFINABLE CONTENTS OF DIGITAL INPUTS

Table 9 Definable Contents of Digital Inputs (Active When GND (B-) Connected)

| No. | Description | Notes |
|-----|-----------------------------------|--|
| 0 | Not Used | |
| 1 | High Temperature Alarm | If these signals are activated after crank disconnect, shutdown alarm will be immediately initiated. |
| 2 | Low OP Alarm | |
| 3 | Reserved | Only warning and not stops if this input is active. |
| 4 | Auxiliary Shutdown | Shutdown alarm will be immediately initiated if this input is active. |
| 5 | High Temperature Cooling Shutdown | When the genset is working normally and this signal is activate, if there is a high temperature situation, the controller will first cool down the generator and then stop |

| No. | Description | Notes |
|-----|------------------------|--|
| | | it; if the signal is deactivated and a high temperature situation occurs, the controller will shut down the genset without cooling down. |
| 6 | Reserved | |
| 7 | Reserved | |
| 8 | Multiplex Level Sensor | Parameter P44 "Fuel Level Sensor" Input is active. |

7.4 SENSOR SELECTION

Table 10 Sensor Selection

| No. | Items | Content | Remark |
|-----|---------------------|---|--|
| 1 | Temperature Sensor | 0 Not used 1 Low digital input is active 2 High digital input is active 3 User defined resistor type 4 VDO 5 SGH (Huanghe sensor) 6 SGD (Dongkang sensor) 7 CURTIS 8 DATCON 9 VOLVO-EC 10 SGX 120 DEGREE | Digital input is digital signal; low or high electrical level can be selected to be active, connecting to earth point will mean that low electrical level is selected, hang in air means high electrical level is selected; cannot be connected to power supply positive. The range of user-defined resistor type sensor is 0-6000Ω, by default SGD sensor is selected. |
| 2 | Oil Pressure Sensor | 0 Not used 1 Low digital input is active 2 High digital input is active 3 User defined resistor type 4 VDO 10Bar 5 SGH (Huanghe sensor) 6 SGD (Dongkang sensor) 7 CURTIS 8 DATCON 10Bar 9 VOLVO-EC 10 SGX 10Bar | Digital input is digital signal; low or high electrical level can be selected to be active, connecting to earth point will mean that low electrical level is selected, hang in air means high electrical level is selected; cannot be connected to power supply positive. The range of user-defined resistor type sensor is 0-6000Ω, by default SGD sensor is selected. |

| No. | Items | Content | Remark |
|-----|-------------------|--|--|
| 3 | Fuel Level Sensor | 0 Not used 1 Low digital input is active 2 High digital input is active 3 User defined resistor type 4 SGH (Huanghe sensor) 5 SGD (Dongkang sensor) 6 Reserved 1 7 Reserved 2 | Digital input is digital signal I; low or high electrical level can be selected to be active, connecting to earth point will mean that low electrical level is selected, hang in air means high electrical level is selected; cannot be connected to power supply positive. The range of user-defined resistor type sensor is 0-6000Ω, by default "Not used" is selected Before selecting fuel level sensor type, digital input type must be set as 8. |

7.5 CONDITIONS OF CRANK DISCONNECT SELECTION

Table 11 Crank Disconnect Conditions Selection

| No | Content |
|----|---|
| 0 | Speed |
| 1 | Generator Frequency |
| 2 | Speed + Generator Frequency |
| 3 | Speed + Oil pressure |
| 4 | Generator Frequency + Oil pressure |
| 5 | Generator Frequency + Speed+ Oil pressure |
| 6 | Oil pressure |

- 1) There are 3 conditions to make starter separate with engine; Speed, generator frequency and oil pressure can be used separately while oil pressure is recommended to use together with speed and generator frequency. The aim is to disconnect the starter motor as soon as possible.
- 2) Speed sensor is the magnetic equipment which be installed in starter for detecting flywheel teeth.
- 3) When set as speed, must ensure that the number of flywheel teeth is as same as setting, otherwise, "over speed shutdown" or "under speed shutdown" may be caused.
- 4) If genset without speed sensor please don't select corresponding items, otherwise, "start fail" or "loss speed signal" maybe caused.
- 5) If genset without oil pressure sensor, please don't select corresponding items.
- 6) If not select generator frequency in crank disconnect setting, controller will not collect and display the relative electric quantity (can be used in water pump set); if not select speed in crank disconnect setting, the speed displayed in controller is calculated by generator signa

8. CONTROLLER FUNCTION SETTING

8.1. PARAMETER SETTING

Hold and press  for 2s to enter into password interface, and the first digit is blinking as follows,

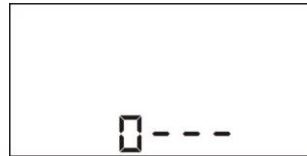

Fig.3 Password Interface







- 1) Press  button to increase the value of the blinking digit and  to decrease the value; when the first digit is set, press  to move the cursor;
- 2) Repeat the same procedure to set the digits from 2nd to 4th;
- 3) If the password is right, enter into the parameter configuration interface (as shown below) which including the serial number of the set items and their parameters; press  to scroll down and  to scroll up;



Fig.4 Parameter Configuration Interface

- 4) Press  to set the current item, and when the first digit starts blinking, use the same way that is used for password to enter the set value.

Attention:

- a) Please change the controller parameters when generator is in standby mode only (e. g. Crank disconnect conditions selection, configurable input, configurable output, various delay), otherwise, shutdown and other abnormal conditions may happen.
- b) Serial number of parameters please reference *Table 7*
- c) The value of each parameter can be set only within a certain range; otherwise, it can't be changed.
- d) Over voltage set value must be higher than under voltage set value, otherwise over voltage and under voltage condition may occur simultaneously.
- e) Over speed set value must be higher than under speed set value, otherwise over speed and under speed condition may occur simultaneously.
- f) Please set the generator frequency value as low as possible when cranking, in order to make the starter be separated quickly as soon as crank disconnect.
- g) Before selecting fuel level sensor type, it is necessary to set a configurable input port type as 8 first.

h) At any time press  can stop current parameter setting immediately.

8.2. LCD CONTRAST ADJUSTMENT





When genset is in standby status, simultaneously hold and press  and  keys for 2s to enter into LCD contrast adjustment interface, and LCD contrast increases one level every 1s without releasing buttons. There are 6 levels to select as requirement.



Fig.5 LCD Contrast

8.3. GENERATOR FLYWHEEL TEETH AUTOMATIC ADJUSTMENT

In manual mode, if crank disconnect conditions select as “2 Speed + Generator Frequency” or “5 Generator Frequency + Speed + Oil Pressure” (generator frequency and speed are not 0), controller will automatic adjust generator flywheel teeth based on gen frequency and poles when simultaneous press  and  keys for 0.5s.

9. SENSOR SETTINGS

- Sensors are connected to the controller are all resistor type. Parts of build-in standard sensor curves in the controller can be selected by users via PC software (details please to see *Table 10*)
- When input the sensor curve, X value (resistor) must be input from small to large, otherwise, mistake occurs.
- If sensor type is set as “not used”, sensor curve is not working and LCD display “---”.
- If there is only low oil pressure alarm switch and without oil pressure sensor, pressure sensor can be set as “low digital input is active” or “high digital input is active”.
- The headmost or backmost values in the vertical coordinates can be set as same as below,

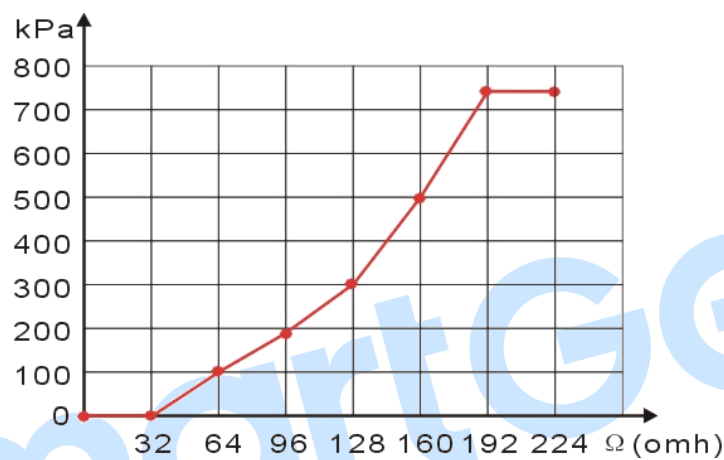

Fig.6 Sensor Curve

Table 12 Normal Pressure Unit Conversion Table

| | N/m ² (pa) | kgf/cm ² | bar | psi |
|----------------------|-----------------------|-----------------------|-----------------------|-----------------------|
| 1Pa | 1 | 1.02x10 ⁻⁵ | 1x10 ⁻⁵ | 1.45x10 ⁻⁴ |
| 1kgf/cm ² | 9.8x10 ⁴ | 1 | 0.98 | 14.2 |
| 1bar | 1x10 ⁵ | 1.02 | 1 | 14.5 |
| 1psi | 6.89x10 ³ | 7.03x10 ⁻² | 6.89x10 ⁻² | 1 |

10. COMMISSIONING

Please make sure the following checks are made before commissioning,

- 1) Ensure all the connections are correct and wires diameter is suitable.
- 2) Ensure that the controller DC power has fuse, controller's positive and negative correctly connected to starting battery.
- 3) Take proper action to prevent engine to crank success (e. g. Remove the connection wire of fuel valve). If checking is OK, make the starting battery power on; choose manual mode and controller will executive routine.
- 4) Set controller under manual mode, press "start" button, genset will start. After the cranking times as setting, controller will send signal of Start Failure; then press "stop" to reset controller.
- 5) Recover the action to prevent engine to crank success (e. g. Connect wire of fuel valve), press start button again, genset will start. If everything goes well, genset will normal running after idle running (if idle run be set). During this time, please watch for engine's running situations and AC generator's voltage and frequency. If abnormal, stop genset and check all wires connection according to this manual.
- 6) Any other questions please contact with SmartGen service personnel.

11. TYPICAL APPLICATION

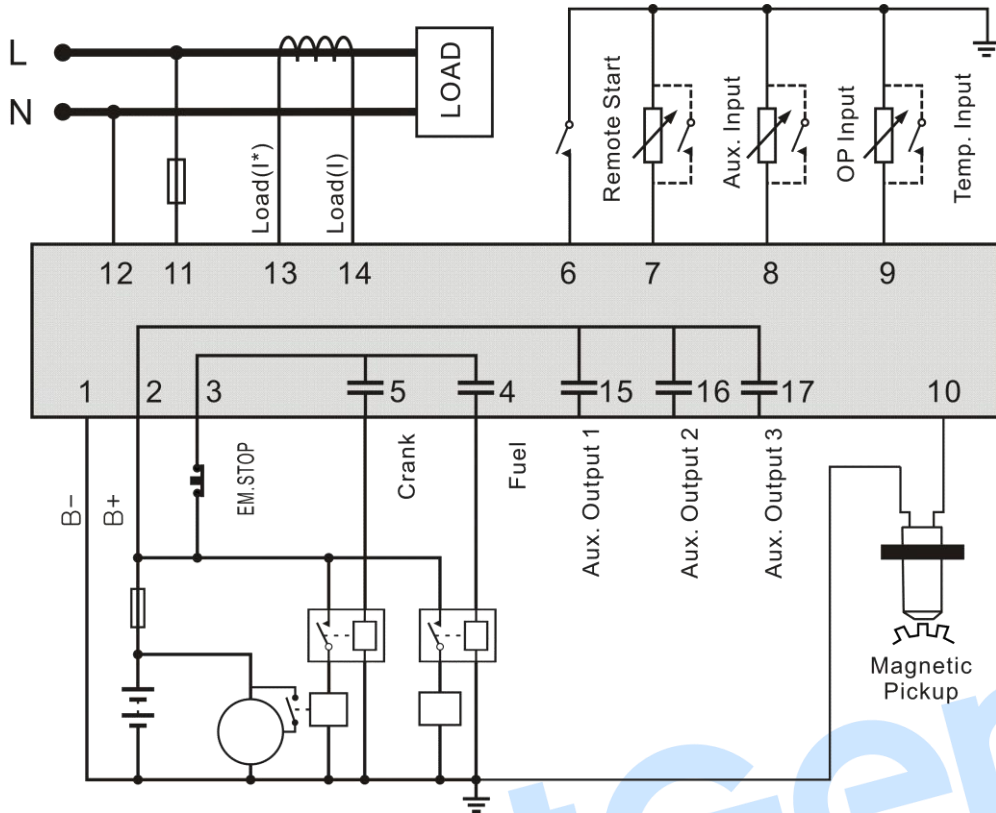

Fig. 7 HGM1790N Typical Application Diagram

⚠ CAUTION: Crank and fuel output ports should be extended large capacity relays.

⚠ CAUTION: When sensor port is configured as "high digital input is active", hang in air means high electrical level; and power supply positive is prohibited to be connected.

12. INSTALLATION

12.1. FIXING CLIPS

- 1) Controller is panel built-in design; it is fixed by clips when installed.
- 2) Withdraw the fixing clip screw (turn anticlockwise) until it reaches proper position.
- 3) Pull the fixing clip backwards (towards the back of the module) ensuring two clips are inside their allotted slots.
- 4) Turn the fixing clip screws clockwise until they are fixed on the panel.

▲NOTE: Care should be taken not to over tighten the screws of fixing clips.

12.2. OVERALL DIMENSION

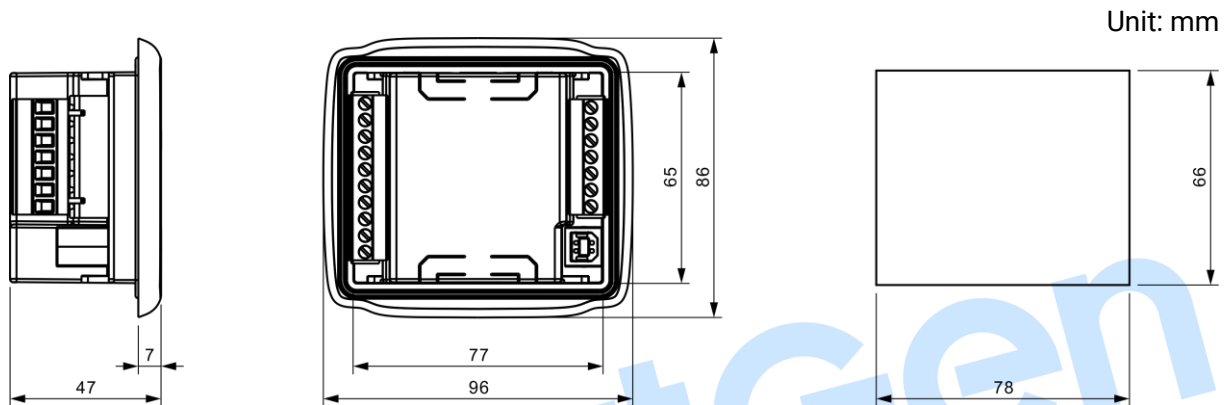

Fig.8 Overall and Cutout Dimensions

□ BATTERY VOLTAGE INPUT

HGM1790N series controller can suit for widely range of battery voltage DC(8~35)V. Negative of battery must be connected with the engine shell. Diameter of wire that connects from power supply to battery must be over 1.5mm². If floating charger configured, please firstly connect output wires of charger to battery's positive and negative directly, then, connect wires from battery's positive and negative to controller's positive and negative input ports in order to prevent charger disturbing the controller's normal working.

□ SPEED SENSOR INPUT

Speed sensor is the magnetic equipment which be installed in starter and for detecting flywheel teeth. Its connection wires to controller should apply for 2 cores shielding line. The shielding layer should connect to No. 1 terminal in controller while another side is hanging in air. The else two signal wires are connected to No.1 and No.10 terminals in controller. The output voltage of speed sensor should be within AC(1~24)V (effective value) during the full speed. AC12V is recommended (in rated speed). When install the speed sensor, let the sensor is spun to contacting flywheel first, then, port out 1/3 lap, and lock the nuts of sensor at last.

□ OUTPUT AND EXPAND RELAYS

All outputs of controller are relay contact output type. If need to expand the relays, please add freewheel diode to both ends of expand relay's coils (when coils of relay have DC current) or,

increase resistance-capacitance return circuit (when coils of relay have AC current), in order to prevent disturbance to controller or others equipment.

□ **AC INPUT**

Current input of controller must be connected to outside current transformer. And the current transformer's secondary side current must be 5A. At the same time, the phases of current transformer and input voltage must correct. Otherwise, the current of collecting and active power maybe not correct.

 **WARNING:** When there is load current, transformer's secondary side is prohibited to open circuit.

□ **WITHSTAND VOLTAGE TEST**

When controller had been installed in control panel, if need the high voltage test, please disconnect controller's all terminal connections, in order to prevent high voltage into controller and damage it.

SmartGen

13. FAULT FINDING

Table 13 Fault Finding

| Symptoms | Possible Solutions |
|---|--|
| Controller no response with power. | Check starting batteries; Check controller connection wirings; Check DC fuse. |
| Genset shutdown | Check the water/cylinder temperature is too high or not; Check the genset AC voltage; Check DC fuse. |
| Low oil pressure alarm after crank disconnect | Check the oil pressure sensor and its connections. |
| High water temp. alarm after crank disconnect | Check the temperature sensor and its connections. |
| Shutdown alarm in running | Check related switch and its connections according to the information on LCD; Check programmable inputs. |
| Crank not disconnect | Check fuel circuit and its connections; Check starting batteries; Check speed sensor and its connections; Refer to engine manual. |
| Starter no response | Check starter connections; Check starting batteries. |