



SmartGen
ideas for power

HAT821

DUAL POWER BUS TIE CONTROLLER

USER MANUAL



SMARTGEN (ZHENGZHOU) TECHNOLOGY CO., LTD.



Chinese trademark

SmartGen English trademark

SmartGen — make your generator *smart*

SmartGen Technology Co., Ltd.

No.28 Jinsuo Road

Zhengzhou

Henan Province

P. R. China

Tel: 0086-(0)371-67988888/67981888

0086-(0)371-67991553/67992951

0086-(0)371-67981000(overseas)

Fax: 0086-(0)371-67992952

Web: www.smartgen.com.cn

www.smartgen.cn

Email: sales@smartgen.cn

All rights reserved. No part of this publication may be reproduced in any material form (including photocopying or storing in any medium by electronic means or other) without the written permission of the copyright holder.

Applications for the copyright holder's written permission to reproduce any part of this publication should be addressed to SmartGen Technology at the address above.

Any reference to trademarked product names used within this publication is owned by their respective companies.

SmartGen Technology reserves the right to change the contents of this document without prior notice.

Table 1 - Software Version

Date	Version	Note
2018-08-16	1.0	Original release.
2020-03-24	1.1	Added and optimized typical application diagram.

CONTENT

1 OVERVIEW	4
2 PERFORMANCE AND CHARACTERISTICS	5
3 SPECIFICATION	6
4 MEASURE AND DISPLAY DATA	7
5 OPERATION.....	8
5.1 INDICATORS.....	8
5.2 KEY FUNCTION DESCRIPTION	9
6 LCD DISPLAY	11
6.1 MAIN SCREEN.....	11
6.2 STATUS DESCRIPTION	12
6.3 MAIN MENU	15
7 PARAMETERS CONFIGURATION.....	16
7.1 ILLUSTRATION	16
7.2 PARAMETERS TABLE	16
7.3 DIGITAL INPUT/OUTPUT FUNCTION DESCRIPTION.....	22
8 HISTORICAL RECORDS.....	28
9 BLACK BOX RECORDS.....	30
10 SWITCH OPERATION	31
10.1 MANUAL OPERATION.....	31
10.2 AUTOMATIC OPERATION.....	32
11 ATS POWER SUPPLY.....	33
12 COMMUNICATION CONFIGURATION AND CONNECTION.....	34
13 TERMINALS	35
14 TYPICAL WIRING DIAGRAM	39
15 INSTALLATION	41
16 CLIPS INSTALLATION.....	41
17 TROUBLE SHOOTING	42

1 OVERVIEW

HAT821 Dual Power Bus Tie controller is intelligent bus-tie dual-power switchover module with configurable function, automatic measurement, LCD display, and digital communication. It combines digitization, intelligence and networking. Automatic measurement and control can reduce incorrect operation, which is an ideal option for dual-power bus-tie switchover products.

The powerful Microprocessor contained within the unit allows for precision voltage (2-way 3-phase) measuring and make accurate judgment and the corresponding volt free digital output port will active when there is over/under voltage, over/under frequency, loss of phase, phase sequence wrong and other abnormal condition occurs. It has compact structure, advanced circuits, simple wiring and high reliability, and can be widely used in electrical automatic control system of electric power, telecommunications, petroleum, coal, metallurgy, railways, municipal administration, intelligent building, etc.

SmartGen

2 PERFORMANCE AND CHARACTERISTICS

- 4.3 inches solid color 240x128 LCD display with white backlight, multilingual display(including English, simplified Chinese or other languages), push-button operation;
- Collect and display 2-way 3-phase voltage, frequency and phase;
- Display S1/S2 total close times;
- Display load 1 and load 2 present continuous power supply time and total power supply time;
- Display S1/S2 total power supply time;
- Over/under voltage, over/under frequency, loss of phase, phase sequence wrong protection;
- Real-time clock (RTC); event log function (event log can record 200 items circularly);
- Suitable for various AC systems (3- phase 4-wire, 3-phase 3-wire, single-phase 2-wire, and 2-phase 3-wire);
- Simultaneously control the closing and opening of the two-way CB switch and the bus-tie CB switch to simplify the control system;
- For Stored-Energy type ATS, its close relay will active after the PF Input is active;
- Automatic/Manual mode. In manual mode, can force the switch to close or open;
- 6 buttons on the panel to manually control breaker switch easily;
- With breaker re-close function;
- Closing output signal can be set as on intervals or as continuous output, which suitable for CB breaker or CC contactor;
- All parameters can be set on site. Passwords authentication ensures authorized staff operation only;
- Applicable for 2 isolated neutral line;
- Enabling switch power supply LO/NO output to provide power for switching coil;
- Widely DC power supply range allows the controller can bear instantaneous 80V DC input;
- Large terminal space allows the controller can bear maximum 625V AC voltage input;
- With 2 isolated RS485 communication interfaces. With "remote controlling, remote measuring, remote communication, remote regulating" function by the ModBus communication protocol. Can remote start/stop the genset and remote control the breaker to close or open;
- USB is convenient to debug parameters and upgrade program locally;
- Modular design, self extinguishing ABS shell, silicone panel, pluggable terminal, built-in mounting, compact structure with easy installation.

3 SPECIFICATION

Table 2 – Performance Parameters

Items	Contents	
Operating Voltage	1. DC8.0V~35.0V, continuous power supply 2. AC(90~305)V power supply A1N1/A2N2	
Power Consumption	<7W(Standby mode:≤2W)	
AC Voltage Input	AC system	
	3P4W (L-L)	(80~530)V
	3P3W (L-L)	(80~625)V DC supply
	1P2W (L-N)	(50~305)V
	2P3W (A-B)	(80~530)V
Rated Frequency	50/60Hz	
Programmable Output 1~6 Relay Capacity	16A AC250V Volts free output	
Programmable Output 7~12 Relay Capacity	8A AC250V Volts free output	
Digital Input	GND (B-) connect is active.	
Communication	1. 2 isolated RS485 interfaces, MODBUS Protocol 2. D-type USB port	
Case Dimensions	260mmx180mmx54mm	
Panel Cutout	242mmx161mm	
Working Conditions	Temperature: (-25~+70)°C; Relative Humidity: (20~93)%RH	
Storage Condition	Temperature: (-25~+70)°C	
Protection Level	IP65: when water proof gasket ring inserted between panel and housing.	
Insulation Strength	Apply AC1.5kV voltage between high voltage terminal and low voltage terminal; The leakage current is not more than 3mA within 1min.	
Weight	1.2kg	

4 MEASURE AND DISPLAY DATA

Table 3 – Display Parameters

No.	Measure & Display Data Items
1	S1/S2 Power Phase Voltage (L1-N,L2-N,L3-N)
2	S1/S2 Power Line Voltage (L1-L2,L2-L3,L3-L1)
3	S1/S2 Power Frequency
4	S1 Total Supply Time
5	S2 Total Supply Time
6	LOAD1/LOAD2 Continuous Power Supply Time (Present)
7	LOAD1/LOAD2 Continuous Power Supply Time (Last Time)
8	LOAD1/LOAD2 Total Power Supply Time
9	QS1 Total Close Times
10	QS2 Total Close Times
11	QTIE Total Close Times
12	Inp ut/Output Port Status
13	Real Time Clock
14	Historical Records & Black Box Records
15	Communication Status

Table 4 - Identification & Abbreviations Explanation

No.	Identification & Abbreviations	Explanation
1	S1	S1 power
2	S2	S2 power
3	QS1	S1 side switch
4	QS2	S2 side switch
5	QTIE	Bus-tie switch
6	PF	Ready for close signal
7	CB	Circuit breaker
8	LOAD1	Load 1
9	LOAD2	Load 2

5 OPERATION



Fig.1 – Penal Indication Drawing

5.1 INDICATORS

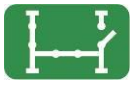
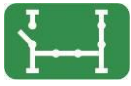







Table 5 – Indicators Description

Indicator Type	Description
Alarm	Slow flashing (1time per sec) when warn alarm occurs. Fast flashing (5 times per sec) when fault alarm occurs.
Man	Light on when the module is in Manual mode.
Auto	Light on when the module is in Auto mode.
IOI	Illuminated: QS1 closed, QS2 closed, LOAD1 powered by S1, LOAD2 powered by S2. Flashing: status switching
IIO	Illuminated: QS1 closed, QTIE closed, LOAD1 and LOAD2 powered by S1. Flashing: status switching
OII	Illuminated: QS1 closed, QS2 closed, LOAD1 and LOAD2 powered by S2. Flashing: status switching
IOO	Illuminated: QS1 closed, LOAD1 powered by S1, LOAD2 disconnect. Flashing: status switching
OOI	Illuminated: QS2 closed, LOAD2 powered by S2, LOAD1 disconnect.



Indicator Type	Description
	Flashing: status switching
000	<p>Illuminated: QS1, QS2, QTIE are all open, LOAD1 and LOAD2 are disconnect.</p> <p>Flashing: status switching</p>

5.2 KEY FUNCTION DESCRIPTION

Table 6 – Buttons Function Description

Icon	Buttons	Function Description
	IOI	<p>Active in Manual mode.</p> <p>After pressing this key, QS1 will close, QTIE will open and QS2 will close, which means LOAD1 powered by S1 and LOAD2 powered by S2.</p>
	IIO	<p>Active in Manual mode.</p> <p>After pressing this key, QS1 will close, QTIE will close and QS2 will open, which means LOAD1 and LOAD2 powered by S1.</p>
	OII	<p>Active in Manual mode.</p> <p>After pressing this key, QS1 will open, QTIE will close and QS2 will close, which means LOAD1 and LOAD2 powered by S2.</p>
	IOO	<p>Active in Manual mode.</p> <p>After pressing this key, QS1 will close, QTIE will open and QS2 will open, which means LOAD1 powered by S1 and LOAD2 disconnect.</p>
	OOI	<p>Active in Manual mode.</p> <p>After pressing this key, QS1 will open, QTIE will open and QS2 will close, which means LOAD2 powered by S2 and LOAD1 disconnect.</p>
	OOO	<p>Active in Manual mode.</p> <p>After pressing this key, QS1 will open, QTIE will open and QS2 will open, which means LOAD1 and LOAD2 disconnect.</p>
	Man/Auto	Manual mode and Auto mode switching.
	Alarm Reset	Pressing this key can reset fault alarm.
	Return/Homepage	<p>When setting parameters, press the key to return back.</p> <p>In main screen, press the key to return the first screen; in other screen, hold and press the key to return to main screen.</p>
	Set/Confirm	<p>In main screen, press the key to enter to menu.</p> <p>In menu screen, press this key can move cursor and confirm setting information.</p>











Icon	Buttons	Function Description
	Up/Alarm Mute	In main screen, press the key to scroll up screen. In menu interface, press this key to up cursor or increase value in setting menu. Mute the alarm.
	Down/Lamp Test	In main screen, press the key to scroll down screen. In menu interface, press this key to down cursor or decrease value in setting menu. In main screen, press the key for seconds to enter lamp test mode, LCD backlit and all LED lamps are lit and LCD screen display black.

SmartGen

6 LCD DISPLAY

6.1 MAIN SCREEN

Table 7 – Screen Display

Items	Display Contents
Homepage	S1 status, S2 status, Switch status; Supply system diagram, QS1 is side switch for S1, QS2 is side switch for S2, QTIE is bus-tie switch; S1/S2 voltage and frequency; S1/S2 priority switch; AutoTrans/Restore status
S1 	S1 line voltage, phase voltage and frequency; S1 total supply time.
S2 	S2 line voltage, phase voltage and frequency; S2 total supply time.
LOAD1 	LOAD1 continuous power supply time (present); LOAD1 continuous power supply time (last time); LOAD1 total power supply time.
LOAD2 	LOAD2 continuous power supply time (present); LOAD2 continuous power supply time (last time); LOAD2 total power supply time.
QF 	QS1 Total Close Times; QS2 Total Close Times; QTIE Total Close Times.
I/O 	Programmable digital input status and auxiliary status; Programmable digital output status.
Comm. 	RS485-1 Comm. status and baud rate; RS485-2 Comm. status and baud rate; USB Comm. status
Alarms 	Present alarm informations (Warn alarm and fault alarm)
Status	Alarm status/working status; Real-time clock; Statusline is showed below in every main screen pages.

6.2 STATUS DESCRIPTION

Table 8 – S1 Voltage Status

No.	Item	Description
1	S1 Available	S1 Normal Delay
2	S1 Unavailable	S1 Abnormal Delay
3	S1 Available	Power supply voltage is within the setting range
4	S1 Blackout	Voltage is 0
5	S1 Over Volt	Voltage is higher than the set value
6	S1 Under Volt	Voltage has fallen below the set value
7	S1 Over Freq	Frequency is higher than the set value
8	S1 Under Freq	Frequency has fallen below the set value
9	S1 Loss of Phase	Loss of any phase of A, B and C
10	S1 Phase Seq Wrong	A-B-C phase sequence is wrong

Table 9 – S2 Voltage Status

No.	Item	Description
1	S2 Available	S2 Normal Delay
2	S2 Unavailable	S2 Abnormal Delay
3	S2 Available	Power supply voltage is within the setting range.
4	S2 Blackout	Voltage is 0.
5	S2 Over Volt	Voltage is higher than the set value.
6	S2 Under Volt	Voltage has fallen below the set value.
7	S2 Over Freq	Frequency is higher than the set value.
8	S2 Under Freq	Frequency has fallen below the set value.
9	S2 Loss of Phase	Loss of any phase of A, B and C.
10	S2 Phase Seq Wrong	A-B-C phase sequence is wrong.

Table 10 – Switch Status

No.	Item	Description
1	Ready to Transfer	Switch transfer begins.
2	QS1 Closing	QS1 closing delay is in progress.
3	QS1 Opening	QS1 opening delay is in progress.
4	QS2 Closing	QS2 closing delay is in progress.
5	QS2 Opening	QS2 opening delay is in progress.
6	Transfer Rest	Interval time between switch transfer
7	Waiting QS1 PF	Before QS1 is closed, it's the delay time to confirm "QS1 PF Input" signal is active.
8	Waiting QS2 PF	Before QS2 is closed, it's the delay time to confirm "QS2 PF Input" signal is active.
9	Waiting QTIE PF	Before QTIE is closed, it's the delay time to confirm "QTIE PF Input" signal is active.
10	Elevator Delay	Elevator control output before ATS transfer.
11	S1 On Load	QS1 was already closed and S1 is taking load1.
12	S2 On Load	QS2 was already closed and S2 is taking load2.
13	Offload	Switch was already opened and load is disconnected.
14	QTIE Closing	QTIE closing delay is in progress.
15	QTIE Opening	QTIE opening delay is in progress.
16	QS1 & QTIE Closed	QS1 and QTIE were already closed and S1 is taking load1 and load2.
17	QS2 & QTIE Closed	QS2 and QTIE were already closed and S2 is taking load1 and load2.
18	QS1 & QS2 Closed	QS2 and QTIE were already closed. S1 is taking load1 and S2 is taking load2.
19	QTIE Closed	QTIE bus-tie switch closed.

Warning alarms are active when controller detects the alarm signals, and alarm indicator will flash slowly (1time per sec). When alarm is reset, indicator is extinguished, which means warn alarms are not latched.

Table 11 – Warning Alarms

No.	Item	Description
1	Forced Open Warn	When the input is active and the action (cut off non-fire supply) select "Warn", it will initiate a warning alarm.

Fault alarms are active when controller detects the alarm signals. Alarm indicator will flash rapidly (5 times per sec) and the alarm will last until it was removed manually. Fault alarms are latched.

Table 12 – Fault Aalrms

No.	Item	Description
1	QS1 Failed to Close	QS1 fail to close.
2	QS1 Failed to Open	QS1 fail to open.



No.	Item	Description
3	QS2 Failed to Close	QS2 fail to close.
4	QS2 Failed to Open	QS2 fail to open.
5	QTIE Failed to Close	QTIE fail to close.
6	QTIE Failed to Open	QTIE fail to open.
7	Forced Open Fault	When the input is active and the action (cut off non-fire supply) select "Fault", it will initiate a fault alarm.
8	Switch Trip Alarm	It will initiate a fault alarm, when the input is active.
9	QS1 Switch Trip Alarm	It will initiate a fault alarm, when the input is active.
10	QS2 Switch Trip Alarm	It will initiate a fault alarm, when the input is active.
11	QTIE Switch Trip Alarm	It will initiate an alarm when the input is active.
12	QS1 Earth&Over Current Fault	It will initiate a fault alarm when the input is active.
13	QS2 Earth&Over Current Fault	It will initiate a fault alarm, when the input is active.

The indication information will continuously display for 2s after it is active.

Table 13 – Indication Information

No.	Item	Description
1	Please Reset The Alarm	When there is fault alarm occurs, the indication will be displayed when change the genset mode to Auto Mode manually.
2	Panel Locked	The information displays when panel lock is active and keys are pressed (except for UP/Down, Confirm and Return Buttons).

Table 14 – Other Status Information

No.	Item	Description
2	QS1 Close Inhibit	QS1 Load Inhibit input is active.
3	QS2 Close Inhibit	QS2 Load Inhibit input is active.
4	QTIE Close Inhibit	QTIE Load Inhibit input is active.
5	Auto Mode	Current mode is Auto mode.
6	Manual Mode	Current mode is Manual mode.

6.3 MAIN MENU

In main screen, press  key will enter into the menu interface.

<ul style="list-style-type: none"> 1. Configuration 2. Data Calibration 3. Historical Records 4. Black Box Records 5. AutoCharge/Recover 6. Language 7. About 	<p>Press Up/Down key to choose parameters (the current line was highlighted with black) and then press Confirm key to enter into the corresponding display screen.</p>
--	--



▲NOTE: Default password is 01234, user can change it in case of others change the parameters setting. Please clearly remember the password after changing. If you forget it, please contact SmartGen services.

▲NOTE: Data Calibration is for factory use only and correct passwords must be input before entered.

SmartGen

7 PARAMETERS CONFIGURATION

7.1 ILLUSTRATION

In the main interface, press  key, choose **Configuration** and press  again to enter into password confirmation interface. If password is correct, enter into parameter setting interface, otherwise, exit to main interface directly. Factory default password is **01234**. In parameters configuration interface, pressing  key to return the prior menu.

7.2 PARAMETERS TABLE

Table 15 – Parameter Configuration Form

No.	Item	Range	Default	Description
AC Config				
1	S1 Volt Normal	(0-3600) s	10	The delay from S1 voltage abnormal to normal.
2	S1 Volt Abnormal	(0-3600)s	5	The delay from S1 voltage normal to abnormal.
3	S2 Volt Normal	(0-3600)s	10	The delay from S2 voltage abnormal to normal.
4	S2 Volt Abnormal	(0-3600)s	5	The delay from S2 voltage normal to abnormal.
5	Master Set	(0~2)	0	0: S1&S2 Master 1: S1 Master 2: S2 Master
6	AC System	(0~3)	0	0: 3 Phase,4 Wire (3P4W) 1: 3 Phase,3 Wire (3P3W) 2: 2 Phase,3 Wire (2P3W) 3: Single Phase,2 Wire (1P2W)
7	PT Fitted	(0-1)	0	0: Disable ; 1: Enable
8	PT Primary	(30-30000)V	100	Primary voltage of voltage transformer
9	PT Secondary	(30-1000)V	100	Secondary voltage of voltage transformer
10	Rated Voltage	(0-30000)V	220	Rated voltage of AC system
11	Over Volt Warn	(0-1)	1	0: Disable ; 1: Enable
12	Set Value	(0-200)%	120	Upper limit value of voltage; it is abnormal if the value has exceeded the set value.
13	Return	(0-200)%	115	Upper limit return value of voltage; it is normal only when the value has fallen below the set value.
14	Under voltage Warn	(0-1)	1	0: Disable ; 1: Enable
15	Set Value	(0-200)%	80	Lower limit value of voltage; it is abnormal if the value has fallen below the set value.
16	Return Value	(0-200)%	85	Lower limit return value of voltage; it is normal only when the value has exceeded



No.	Item	Range	Default	Description
				the set value.
17	Rated Frequency	(10.0-75.0)Hz	50.0	Rated frequency of AC system
18	Over Frequency Warn	(0-1)	1	0: Disable ; 1: Enable
19	Set Value	(0-200)%	110	Upper limit value of frequency; it is abnormal if the value has exceeded the set value.
20	Return Value	(0- 200)%	104	Upper limit return value of frequency; it is normal only when the value has fallen below the set value.
21	Under Frequency Warn	(0-1)	1	0: Disable ; 1: Enable
22	Set Value	(0- 200)%	90	Lower limit value of frequency; it is abnormal if the value has fallen below the set value.
23	Return Value	(0- 200)%	96	Lower limit return value of frequency; it is normal only when the value has exceeded the set value.
24	Phase Sequence Wrong	(0-1)	1	0: Disable ; 1: Enable
Switch				
1	Switch Power Type	(0~1)	1	0: DC Supply; 1: AC Supply
2	AC Volt Lower Limit	(0~100)%	70	Lower limit voltage of switch power; The switch cannot transfer when the value has fallen below the set value.
3	AC Volt Upper Limit	(0~200)%	200	Upper limit voltage of switch power; The switch cannot transfer when the value has exceeded the set value.
4	Auto Charge/Recover	(0-1)	1	0: Auto Charge Man Rec. 1: Auto Charge/Rec.
5	Fixed Close/Open Time	(0-1)	0	0: Disable ; 1: Enable Disable: The output time was judged depends on the close relay; the longest output time up to the set delay. Enable: The output time last for the preset time.
6	Close Delay	(0.1-20.0)s	5.0	Pulse time of close relay.
7	Open Delay	(0.1-20.0)s	5.0	Pulse time of open relay.
8	Transfer Interval	(0-9999)s	1	Interval time from S1 switch open to S2 switch close; or from S2 switch open to S1 switch close.
9	Forced Open Action	(0-1)	0	0: Warn Alarm 1: Fault Alarm
10	Continually Close	(0-1)	0	0: Disable ; 1: Enable If "Enable" is selected, "Close Time" and "Open Time" are deactivated.



No.	Item	Range	Default	Description
11	Elevator Enable	(0~1)	0	0: Disable ; 1: Enable
12	Elevator Delay	(0~300)s	300	Delay time before load disconnect and switch transfer. It is used for controlling the running elevator to stop at the nearest level until the switch is transferred over.
Digit Inputs				
1	Digital Input 1	(0~50)	1	Forced Open
2	Active Type	(0~1)	0	0: Close to activate; 1: Open to activate
3	Digital Input 2	(0~50)	46	QS1 Trip Fault
4	Active Type	(0~1)	0	0: Close to activate; 1: Open to activate
5	Digital Input 3	(0~50)	47	QS2 Trip Fault
6	Active Type	(0~1)	0	0: Close to activate; 1: Open to activate
7	Digital Input 4	(0~50)	48	QTIE Trip Fault
8	Active Type	(0~1)	0	0: Close to activate; 1: Open to activate
9	Digital Input 5	(0~50)	0	Not Used
10	Active Type	(0~1)	0	0: Close to activate; 1: Open to activate
11	Digital Input 6	(0~50)	0	Not Used
12	Active Type	(0~1)	0	0: Close to activate; 1: Open to activate
13	Digital Input 7	(0~50)	0	Not Used
14	Active Type	(0~1)	0	0: Close to activate; 1: Open to activate
15	Digital Input 8	(0~50)	0	Not Used
16	Active Type	(0~1)	0	0: Close to activate; 1: Open to activate
Relay Outputs				
1	Relay Output 1	(0~1)	0	0: Output (NO) 1: Output (NC)
2	Contents Setting	(0~95)	34	QS1 Close Control
3	Relay Output 2	(0~1)	0	0: Output (NO) 1: Output (NC)
4	Contents Setting	(0~95)	35	QS1 Open Control
5	Relay Output 3	(0~1)	0	0: Output (NO) 1: Output (NC)
6	Contents Setting	(0~95)	36	QS2 Close Control
7	Relay Output 4	(0~1)	0	0: Output (NO) 1: Output (NC)

No.	Item	Range	Default	Description
8	Contents Setting	(0~95)	37	QS2 Open Control
9	Relay Output 5	(0~1)	0	0: Output (NO) 1: Output (NC)
10	Contents Setting	(0~95)	94	QTIE Close Control
11	Relay Output 6	(0~1)	0	0: Output (NO) 1: Output (NC)
12	Contents Setting	(0~95)	95	QTIE Open Control
13	Relay Output 7	(0~1)	0	0: Output (NO) 1: Output (NC)
14	Contents Setting	(0~95)	1	Custom Combined 1
15	Relay Output 8	(0~1)	0	0: Output (NO) 1: Output (NC)
16	Contents Setting	(0~95)	11	Common Alarm
17	Relay Output 9	(0~1)	0	0: Output (NO) 1: Output (NC)
18	Contents Setting	(0~95)	0	Not Uesd
19	Relay Output 10	(0~1)	0	0: Output (NO) 1: Output (NC)
20	Contents Setting	(0~95)	0	Not Uesd
Custom Combined Outputs				
1	Combined 1 Or Out 1 Active Type	(0~1)	0	0: Output (NO) 1: Output (NC)
2	Combined 1 Or Out 1 Contents Setting	(0~95)	23	S1 Available
3	Combined 1 Or Out 2 Active Type	(0~1)	0	0: Output (NO) 1: Output (NC)
4	Combined 1 Or Out 2 Contents Setting	(0~95)	25	S2 Available
5	Combined 1 And Out Active Type	(0~1)	1	0: Output (NO) 1: Output (NC)
6	Combined 1 And Out Contents Setting	(0~95)	0	Not Uesd
7	Combined 2 Or Out 1 Active Type	(0~1)	0	0: Output (NO) 1: Output (NC)
8	Combined 2 Or Out 1 Contents Setting	(0~95)	0	Not Uesd
9	Combined 2 Or Out 2 Active Type	(0~1)	0	0: Output (NO) 1: Output (NC)
10	Combined 2 Or Out 2 Contents Setting	(0~95)	0	Not Uesd
11	Combined 2 And Out Active Type	(0~1)	0	0: Output (NO) 1: Output (NC)
12	Combined 2 And Out	(0~95)	0	Not Uesd



No.	Item	Range	Default	Description
	Contents Setting			
13	Combined 3 Or Out 1 Active Type	(0~1)	0	0: Output (NO) 1: Output (NC)
14	Combined 3 Or Out 1 Contents Setting	(0~95)	0	Not Uesd
15	Combined 3 Or Out 2 Active Type	(0~1)	0	0: Output (NO) 1: Output (NC)
16	Combined 3 Or Out 2 Contents Setting	(0~95)	0	Not Uesd
17	Combined 3 And Out Active Type	(0~1)	0	0: Output (NO) 1: Output (NC)
18	Combined 3 And Out Contents Setting	(0~95)	0	Not Uesd
19	Combined 4 Or Out 1 Active Type	(0~1)	0	0: Output (NO) 1: Output (NC)
20	Combined 4 Or Out 1 Contents Setting	(0~95)	0	Not Uesd
21	Combined 4 Or Out 2 Active Type	(0~1)	0	0: Output (NO) 1: Output (NC)
22	Combined 4 Or Out 2 Contents Setting	(0~95)	0	Not Uesd
23	Combined 4 And Out Active Type	(0~1)	0	0: Output (NO) 1: Output (NC)
24	Combined 4 And Out Contents Setting	(0~95)	0	Not Uesd
25	Combined 5 Or Out 1 Active Type	(0~1)	0	0: Output (NO) 1: Output (NC)
26	Combined 5 Or Out 1 Contents Setting	(0~95)	0	Not Uesd
27	Combined 5 Or Out 2 Active Type	(0~1)	0	0: Output (NO) 1: Output (NC)
28	Combined 5 Or Out 2 Contents Setting	(0~95)	0	Not Uesd
29	Combined 5 And Out Active Type	(0~1)	0	0: Output (NO) 1: Output (NC)
30	Combined 5 And Out Contents Setting	(0~95)	0	Not Uesd
31	Combined 6 Or Out 1 Active Type	(0~1)	0	0: Output (NO) 1: Output (NC)
32	Combined 6 Or Out 1 Contents Setting	(0~95)	0	Not Uesd
33	Combined 6 Or Out 2 Active Type	(0~1)	0	0: Output (NO) 1: Output (NC)
34	Combined 6 Or Out 2 Contents Setting	(0~95)	0	Not Uesd



No.	Item	Range	Default	Description
35	Combined 6 And Out Active Type	(0~1)	0	0: Output (NO) 1: Output (NC)
36	Combined 6 And Out Contents Setting	(0~95)	0	Not Uesd
Module Settings				
1	Language	(0~2)	0	0: Simplified Chinese 1: English 2: Other (Language can be set via PC software, Default: Traditional Chinese)
2	Password	(00000~65535)	01234	For entering parameters setting.
3	Power On Mode	(0~2)	0	0: Last Mode (reserved the mode before power off) 1: Manual 2: Auto
4	Module Address	(1~254)	1	RS485 communication address
5	RS485-1 Baud	(0~3)	2	0: 2400 bps 1: 4800 bps 2: 9600 bps 3: 19200 bps
6	RS485-1 Stop Bit	(1~2)	2	2 stop bits or 1 stop bit can be set.
7	RS485-2 Baud	(0~3)	2	0: 2400 bps 1: 4800 bps 2: 9600 bps 3: 19200 bps
8	RS485-2 Stop Bit	(1~2)	2	2 stop bits or 1 stop bit can be set.
9	Date and Time			
10	Controller Description 1	(0~20) characters		“About” information is displayed. Any characters can be inputted via PC software (letter occupies 1 character, Chinese character occupies 2.).
11	Controller Description 2	(0~20) characters		

7.3 DIGITAL INPUT/OUTPUT FUNCTION DESCRIPTION

7.3.1 INPUT PORTS FUNCTION

Table 16 – Input Ports Function Description

No.	Item	Description
0	Not Used	Invalid
1	Forced Open	No matter the genset is in manual mode or auto mode, when the input is active, this will force the breaker to transfer the ATS to OFF position. LOAD1 and LOAD2 disconnected.
2	Reserved	
3	Reserved	
4	Lamp Test	When active, all LED lights on the front panel are illuminated and the backlight of the LCD is illuminated while the LCD screen is black in color.
5	Reserved	
6	Reserved	
7	Reserved	
8	Breaker Trip Input	Trip failure input, if input is active, controller will initiate “Breaker Trip Fault” alarm, and forced enter into manual mode at the same time; if input is inactive, alarm can be reset manually.
9	S1 Close Inhibit	In Manual mode, S1 manual close is inhibited; if breaker already closed, users should open it manually. In Auto mode, if breaker already closed, then QS1 disconnect.
10	S2 Close Inhibit	In Manual mode, S2 manual close is inhibited; if breaker already closed, users should open it manually. In Auto mode, if breaker already closed, then QS2 disconnect.
11	QS1 Breaker PF Input	QS1 PF signal input, it needs to wait QS1 PF active before it closes.
12	QS2 Breaker PF Input	QS2 PF signal input, it needs to wait QS2 PF active before it closes.
13	Reserved	
14	Reserved	
15	Alarm Reset	Reset the current alarm.
16	Alarm Mute	Silence the audible alarm.
17	Reserved	
18	Reserved	
19	S1 Master Input	Set S1 master use compulsively.
20	S2 Master Input	Set S2 master use compulsively.
21	Forced Manual Mode	Set the controller in Manual mode compulsively.



No.	Item	Description
22	Forced Auto Mode	Set the controller in Auto mode compulsively.
23	Panel Lock	Panel button operation are inhibited (Except Up, Down, Confirm, and Return keys)
24	Reserved	
25	Reserved	
26	Simulate S1 OK	Simulate S1 voltage is normal; the S1 voltage abnormal delay is deactivated.
27	Simulate S2 OK	Simulate S2 voltage is normal; the S2 voltage abnormal delay is deactivated.
28	QS1 Earth&Over Current Fault	When input is active, QS1 won't close.
29	QS1 Earth&Over Current Fault	When input is active, QS2 won't close.
30	Reserved	
31	Reserved	
32	Reserved	
33	Auto Charge/Rec.	If this item is configured, then auto charge/recover status is mainly based on input port status. Auto charge/recover when the input active, auto transfer/nonrestore when invalid.
34	Reserved	
35	QTIE Close Inhibit	In Manual mode, QTIE manual close is inhibited; if breaker already closed, users should open it manually. In Auto mode, if breaker already closed, then QTIE disconnect.
36	QTIE PF Input	When the QTIE PF input is active, QTIE close relay will activated.
37	Simulate KEY OOO	Same function with Panel OOO Key. Please use reset key to control ATS to transfer to OOO.
38	Simulate KEY OOI	Same function with Panel OOI Key. Please use reset key to control ATS to transfer to OOI.
39	Simulate KEY IOO	Same function with Panel IOO Key. Please use reset key to control ATS to transfer to IOO.
40	Simulate KEY OII	Same function with Panel OII Key. Please use reset key to control ATS to transfer to OII.
41	Simulate KEY IIO	Same function with Panel IIO Key. Please use reset key to control ATS to transfer to IIO.
42	Simulate KEY IOI	Same function with Panel IOI Key. Please use reset key to control



No.	Item	Description
		ATS to transfer to IOI.
43	Reserved	
44	Simulate Manual/Auto Key	
45	Remote Control Inhibit	
46	QS1 Trip Fault	
47	QS2 Trip Fault	
48	QTIE Trip Fault	
49	S1 Supply QTIE Open	
50	S2 Supply QTIE Open	

7.3.2 OUTPUT PORTS FUNCTION

Table 17 – Output Ports Function Description

No.	Items	Description
0	Not Used	Invalid
1	Custom Combined 1	Output status please to see corresponding custom combination.
2	Custom Combined 2	
3	Custom Combined 3	
4	Custom Combined 4	
5	Custom Combined 5	
6	Custom Combined 6	
7	Reserved	
8	Reserved	
9	Reserved	
10	Reserved	
11	Common Alarm	It includes fault alarm and warn alarm.
12	Common Fault Alarm	It includes “Transition Fault” alarm, “Force Open Fault” alarm and “Over Current” alarm.
13	Common Warn Alarm	It includes “Force Open Fault” alarm.
14	Transition Fault	It includes “QS1 Fail to Close” alarm, “QS1 Fail to Open” alarm, “QS2 Fail to Close” alarm, “QS2 Fail to Open” alarm, “QTIE Fail to Close” alarm, “QTIE Fail to Open” alarm.
15	Audible Alarm	Action when common alarm occurs. Can be connected annunciator externally. When “alarm mute” input is active or 60s delay has expired, it can remove the alarm.
16	Reserved	
17	Reserved	
18	Reserved	
19	Elevator Control	Output before the load disconnect or switch transfer. Used



No.	Items	Description
		for control the running elevator stop at the nearest floor until the switch transfer is terminated.
20	Reserved	
21	Reserved	
22	Reserved	
23	S1 Available	Output when S1 power is normal.
24	S1 Unavailable	Output when S1 power is abnormal.
25	S2 Available	Output when S2 power is normal.
26	S2 Unavailable	Output when S2 power is abnormal.
27	Reserved	
28	Reserved	
29	Reserved	
30	Auto Mode	Output when the genset is in Auto mode.
31	Manual Mode	Output when the genset is in Manual mode.
32	Reserved	
33	Reserved	
34	QS1 Close Control	Control the QS1 switch to close.
35	QS1 Open Control	Control the QS1 switch to open.
36	QS2 Close Control	Control the QS2 switch to close.
37	QS2 Open Control	Control the QS2 switch to open.
38	Reserved	
39	Reserved	
40	Reserved	
41	Reserved	
42	Reserved	
43	QTIE Closed Input	The close status of QTIE switch
44	Reserved	
45	QS1 Closed Input	The close status of S1 switch
46	QS2 Closed Input	The close status of S2 switch
47	Reserved	
48	Reserved	
49	Reserved	
50	Reserved	
51	Reserved	
52	Reserved	
53	Remote Control	Remote control the output via communication command.
54	Input 1 Status	Aux. Input status.
55	Input 2 Status	



No.	Items	Description
56	Input 3 Status	
57	Input 4 Status	
58	Input 5 Status	
59	Input 6 Status	
60	Input 7 Status	
61	Input 8 Status	
62	Reserved	
63	Reserved	
64	S1 Blackout	S1 power supply status
65	S1 Over Volt	
66	S1 Under Volt	
67	S1 Over Freq	
68	S1 Under Freq	
69	S1 Loss Of Phase	
70	S1 Phase Seq Wrong	
71	Reserved	
72	Reserved	
73	S2 Blackout	S2 power supply status
74	S2 Over Volt	
75	S2 Under Volt	
76	S2 Over Freq	
77	S2 Under Freq	
78	S2 Loss of Phase	
79	S2 Phase Seq Wrong	
80	Reserved	
81	Reserved	
82	Reserved	
83	Reserved	
84	Switching	Output during the switch transfer process.
85	Reserved	
86	Reserved	
87	Reserved	
88	Reserved	
89	Breaker Trip Fault	
90	QS1 Trip Fault	
91	Reserved	
92	Reserved	
93	QTIE Trip Fault	
94	QTIE Close Control	Control QTIE to close
95	QTIE Open Control	Control QTIE to open

7.3.3 CUSTOM COMBINED

Defined combination output is composed by 3 parts, OR condition output SW1, OR condition output SW2, AND condition output SW3.

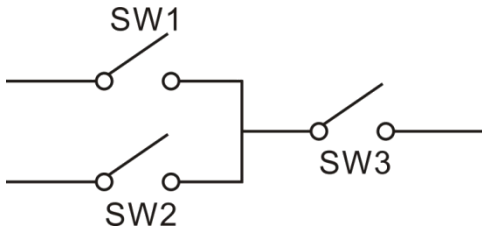

SW1 or SW2 is **TRUE**, while SW3 is **TRUE**, Defined combination output is active;

SW1 and SW2 are **FALSE**, or SW3 is **FALSE**, Defined combination output is deactivated.

NOTE: SW1, SW2, SW3 can be set as any contents except for “defined combination output” in the output setting.

NOTE: 3 parts of defined combination output (SW1, SW2, SW3) couldn't include or recursively include themselves.

Example,

Contents of OR condition output SW1: output port 1 is active;

Close when OR condition output SW1 is active /inactive: close when active (disconnect when inactive);

Contents of OR condition output SW2, output port 2 is active;

Close when OR condition output SW2 is active /inactive: close when active (disconnect when inactive);



Contents of AND condition output SW3: output port 3 is active;

Close when AND condition output SW3 is active /inactive: close when active (disconnect when inactive);

When input port 1 active or input port 2 active, if input port 3 is active, Defined combination output is outputting; If input port 3 inactive, Defined combination output is not outputting;

When input port 1 inactive and input port 2 inactive, whatever input port 3 is active or not, Defined combination output is not outputting.

8 HISTORICAL RECORDS

On the main screen press  key and select **Historical Records**, and then press  key again, the screen will show the historical records interface.

Each record includes:

- Record date and time
- Record type
- Event log
- S1 power supply status
- S2 power supply status
- S1 3-phase voltage
- S2 3-phase voltage
- S1 frequency
- S2 frequency

Maximum pieces of historical record are 200. The first record is latest, and users could check every records by dredge up/down. The latest record will cover the oldest one when records amount exceed 200.

Event log type includes: Action Event, Warn Event and Fault Event. All fault event actions are fault alarm while all warn event actions are warn alarm.

Table 18 – Action Events List

No.	Action Events	Description
1.	Closing QS1	Record when the QS1 close relay activated.
2.	Closing QS2	Record when the QS2 close relay activated.
3.	Opening QS1	Record when the QS1 open relay activated.
4.	Opening QS2	Record when the QS2 open relay activated.
5.	Closing QTIE	Record when the QTIE close output.
6.	Opening QTIE	Record when the QTIE open output.
7.	Auto Mode	Record when the genset mode transferred to Auto Mode.
8.	Manual Mode	Record when the genset mode transferred to Module Mode.

Table 19 – Operation Events List



No.	Operation Events	Description
1	Manual Key OOO	Press this key to execute OOO action in manual mode.
2	Manual Key OOI	Press this key to execute OOI action in manual mode.
3	Manual Key IOO	Press this key to execute IOO action in manual mode.
4	Manual Key IIO	Press this key to execute IIO action in manual mode.
5	Manual Key OII	Press this key to execute OII action in manual mode.



No.	Operation Events	Description
6	Manual Key IOI	Press this key to execute IOI action in manual mode.
7	Remote Key OOO	Using remote communication command to execute OOO action in manual mode.
8	Remote Key OOI	Using remote communication command to execute OOI action in manual mode.
9	Remote Key IOO	Using remote communication command to execute IOO action in manual mode.
10	Remote Key IIO	Using remote communication command to execute IIO action in manual mode.
11	Remote Key OII	Using remote communication command to execute OII action in manual mode.
12	Remote Key IOI	Using remote communication command to execute IOI action in manual mode.

SmartGen

9 BLACK BOX RECORDS

On the main screen press  key and select **Black Box Records**, and then press  key again, the screen will show the black box records interface.

Maximum pieces of black box record are 5. Every event records total 60s (before 50s and after 10s) data information of this event, and record once per second. There are total 60 groups of data.

Each record includes:

- Record date and time
- Record type
- Event log
- S1 power supply status
- S2 power supply status
- S1 3-phase voltage
- S2 3-phase voltage
- S1 frequency
- S2 frequency

Black box is loop record, the latest record will cover the oldest one when records amount exceed 5. The first record is latest. Users could jump to next record by pressing , and check details by pressing up/down button.

Event log type: the action event in auto mode.

Table 20 – Action Events List

No.	Action Events	Description
1	Auto Action OOO	In auto mode, controller controls breaker transfer to OOO based on the present status and settings.
2	Auto Action OOI	In auto mode, controller controls breaker transfer to OOI based on the present status and settings.
3	Auto Action IOO	In auto mode, controller controls breaker transfer to IOO based on the present status and settings.
4	Auto Action IIO	In auto mode, controller controls breaker transfer to IIO based on the present status and settings.
5	Auto Action OII	In auto mode, controller controls breaker transfer to OII based on the present status and settings.
6	Auto Action IOI	In auto mode, controller controls breaker transfer to IOI based on the present status and settings.
7	Auto Action OIO	In auto mode, controller controls breaker transfer to OIO based on the present status and settings.







10 SWITCH OPERATION

10.1 MANUAL OPERATION

Manual mode is selected by pressing the  button; a LED besides the button will illuminate to confirm the operation.

ATS will start to switch immediately after pressing “Switch Key”. During the switching, corresponding lamps will flash, and then the lamp will be normally illuminated when switch is done. If fail to close or fail to open occurs in the switching process, the controller will alarm (Switch key is still active and the operation can be redone).

Table 21 – Manual Transfer Keys

Icon	Key Name	Description
	IOI	After pressing this key, QS1 will close, QTIE will open, and QS2 will close, which means LOAD1 will be powered by S1 and LOAD2 will be powered by S2.
	IIO	After pressing this key, QS1 will close, QTIE will close, and QS2 will open, which means LOAD1 and LOAD2 will be powered by S1.
	OII	After pressing this key, QS1 will open, QTIE will close, and QS2 will close, which means LOAD1 and LOAD2 will be powered by S2.
	IOO	After pressing this key, QS1 will close, QTIE will open, and QS2 will open, which means LOAD1 will be powered by S1 and LOAD2 will be disconnected.
	OOI	After pressing this key, QS1 will open, QTIE will open, and QS2 will close, which means LOAD2 will be powered by S2 and LOAD1 will be disconnected.
	OOO	After pressing this key, QS1 will open, QTIE will open, and QS2 will open, which means LOAD1 and LOAD2 will be disconnected.

10.2 AUTOMATIC OPERATION

Auto mode is selected by pressing the  button; a LED besides the button will illuminate to confirm the operation.

Under auto mode, the controller will switch automatically to ensure power supply for LOAD1 and LOAD2 according to S1 S2 status, switch priority and AutoCharge/Recover status.

Table 22 – Auto Breaker Transfer Logic

Power Status	Breaker and Load Status	S1&S2 Master	S1 Master	S2 Master
S1 Normal S2 Normal	Breaker Status	Status IOI QS1 Close QTIE Open QS2 Close	Status IIO QS1 Close QTIE Close QS2 Open	Status OII QS1 Open QTIE Close QS2 Close
	Load Status	S1 Supply LOAD1 S2 Supply LOAD2	S1 Supply LOAD1 and LOAD2	S2 Supply LOAD1 and LOAD2
S1 Normal S2 Abnormal	Breaker Status	Status IIO QS1 Close QTIE Close QS2 Open		
	Load Status	S1 Supply LOAD1 and LOAD2		
S1 Abnormal S2 Normal	Breaker Status	Status OII QS1 Open QTIE Close QS2 Close		
	Load Status	S2 Supply LOAD1 and LOAD2		
S1 Abnormal S2 Abnormal (With under volt trip function)	Breaker Status	Status OOO QS1 Open QTIE Open QS2 Open		
	Load Status	LOAD1 and LOAD2 power off		

During the switching process, if fail to close or close inhibit occurs, the corresponding switch will close no more, and other switches that can execute close action will supply power to LOAD1/LOAD2 in prior.

11 ATS POWER SUPPLY

Switch Power Type can be set as DC Power or AC Power. If DC Power is selected, then the switch can be transferred at any time (even when both S1 and S2 are outage). If AC Power is selected, whether the power is normal or not should be judged according to the AN voltage status of S1 and S2 and AC power voltage.

The controller will intelligent control to supply when the power of ATS switch is from S1 and S2. As long as 1 voltage of S1 and S2 is normal, the controller can ensure ATS voltage power normal and can be transferred properly. When ATS voltage power is from LO and NO, it will send close/open signal only if the controller detects voltage power normal.

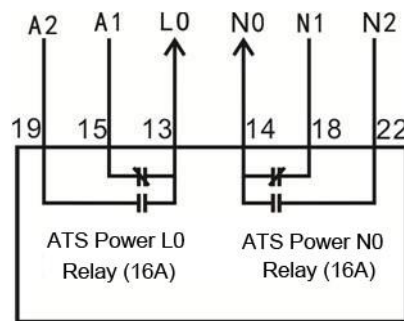

Fig.2 – Internal Wiring of ATS Power LO-NO Output

12 COMMUNICATION CONFIGURATION AND CONNECTION

HAT821 ATS controller equips with 2 RS485 serial ports which enable the connection of LAN. It uses MODBUS-RTU protocol via PC or system software, it can also be applicable to dual power switching management to factories, telecom, industrial and civil buildings, which achieves “remote control, remote measuring, remote communication” functions.

More information of Communication Protocol, please refer to “HAT821 Communication Protocol”

Communication parameters:

Module address	1 (range: 1-254)
Baud rate	9600 bps (2400/4800/9600/19200bps)
Data bit	8-bit
Parity bit	None
Stop bit	2 bits (1 bit or 2 bits)

There is a D-type USB port which can be used to connect PC for software upgrading and parameter setting.

SmartGen

13 TERMINALS

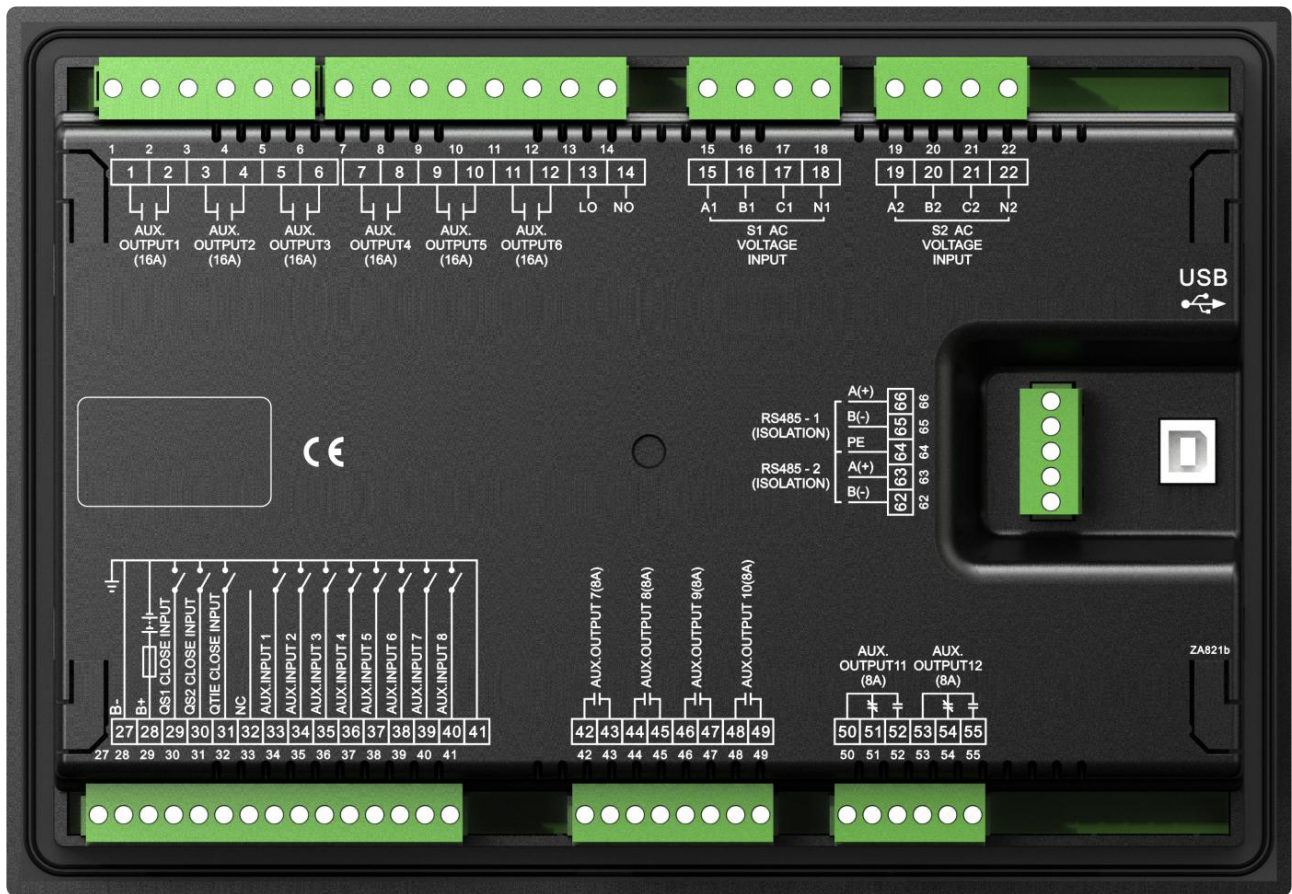

Fig.3 – Controller Rear Panel Drawing

Table 23 – Inputs/Outputs Function Description

No.	Items	Description	Remark
1	AUX.OUTPUT1	Relay Output1	Default: QS1 Close Control
2			Volts free; Relay contact; Normally Open output. Capacity: 250V16A
3	AUX.OUTPUT2	Relay Output2	Default: QS1 Open Control
4			Volts free; Relay contact; Normally Open output. Capacity: 250V16A
5	AUX.OUTPUT3	Relay Output3	Default: QS2 Close Control
6			Volts free; Relay contact; Normally Open output. Capacity: 250V16A
7	AUX.OUTPUT4	Relay Output4	Default: QS2 Open Control
8			Volts free; Relay contact; Normally Open output. Capacity: 250V16A
9	AUX.OUTPUT5	Relay Output5	Default: QTIE Close Control



No.	Items	Description	Remark
10			Volts free; Relay contact; Normally Open output. Capacity: 250V16A
11	AUX.OUTPUT6	Relay Output6	Default: QTIE Open Control
12			Volts free; Relay contact; Normally Open output. Capacity: 250V16A
13	LO	ATS Power L	Power supply for ATS switching
14	NO	ATS Power N	
15	A1	S1 AC System 3P4W voltage input	For single phase, only connect A1, N1
16	B1		
17	C1		
18	N1		
19	A2	S2 AC System 3P4W voltage input	For single phase, only connect A2, N2
20	B2		
21	C2		
22	N2		
27	B-	Connect to DC negative pole	Ground terminal
28	B+	Connect to DC positive pole	DC(8-35)V; Power supplied by controller.
29	QS1 CLOSE INPUT	QS1 Close Status Input	Detect QS1 close status, volts free, relay contact. Ground connected is active.
30	QS2 CLOSE INPUT	QS2 Close Status Input	Detect QS2 close status, volts free, relay contact. Ground connected is active.
31	QTIE CLOSE INPUT	QTIE Close Status Input	Detect QTIE close status, volts free, relay contact. Ground connected is active.
32	NC	Null	This terminal is not defined.
33	AUX. INPUT 1	Digital Input1	Default: Forced Open Ground connected is active.
34	AUX. INPUT 2	Digital Input2	Default: QS1 Trip Fault Ground connected is active.
35	AUX. INPUT 3	Digital Input3	Default: QS2 Trip Fault Ground connected is active.
36	AUX. INPUT 4	Digital Input4	Default: QTIE Trip Fault



No.	Items	Description	Remark
			Ground connected is active.
37	AUX. INPUT 5	Digital Input5	Default: Not Used Ground connected is active.
38	AUX. INPUT 6	Digital Input6	Default: Not Used Ground connected is active.
39	AUX. INPUT 7	Digital Input7	Default: Not Used Ground connected is active.
40	AUX. INPUT 8	Digital Input8	Default: Not Used Ground connected is active.
41	B-(GND)	Ground terminal	Connect to B- internally.
42	AUX. OUTPUT 7	Relay Output7	Default: Costom Combined 1
43			Volts free; Relay contact; Normally Open output. Capacity: 250V8A
44	AUX. OUTPUT 8	Relay Output8	Default: Common Alarm
45			Volts free; Relay contact; Normally Open output. Capacity: 250V8A
46	AUX. OUTPUT 9	Relay Output9	Default: Not Used
47			Volts free; Relay contact; Normally Open output. Capacity: 250V8A
48	AUX. OUTPUT 10	Relay Output10	Default: Not Used
49			Volts free; Relay contact; Normally Open output. Capacity: 250V8A
50	AUX. OUTPUT 11	COM	Relay Output11
51		Normally Close	
52		Normally Open	
53	AUX. OUTPUT 12	COM	Relay Output12
54		Normally Close	
55		Normally Open	
62	RS485-2 B(-)	RS485-2 communication port	120Ω impedance matched resistance should be connected according to the different situation.
63	RS485-2 A(+)		
64	PE	Ground terminal	



No.	Items	Description	Remark
65	RS485-1 B(-)	RS485-1 communication port	120Ω impedance matched resistance should be connected according to the different situation.
66	RS485-1 A(+)		
USB	USB	D-type USB communication port	Parameters setting and software upgrading via PC

NOTE: When the external connected lead of the digital input port exceeds 5 meters, it is recommended to extend the input lead through an external relay.

SmartGen

14 TYPICAL WIRING DIAGRAM

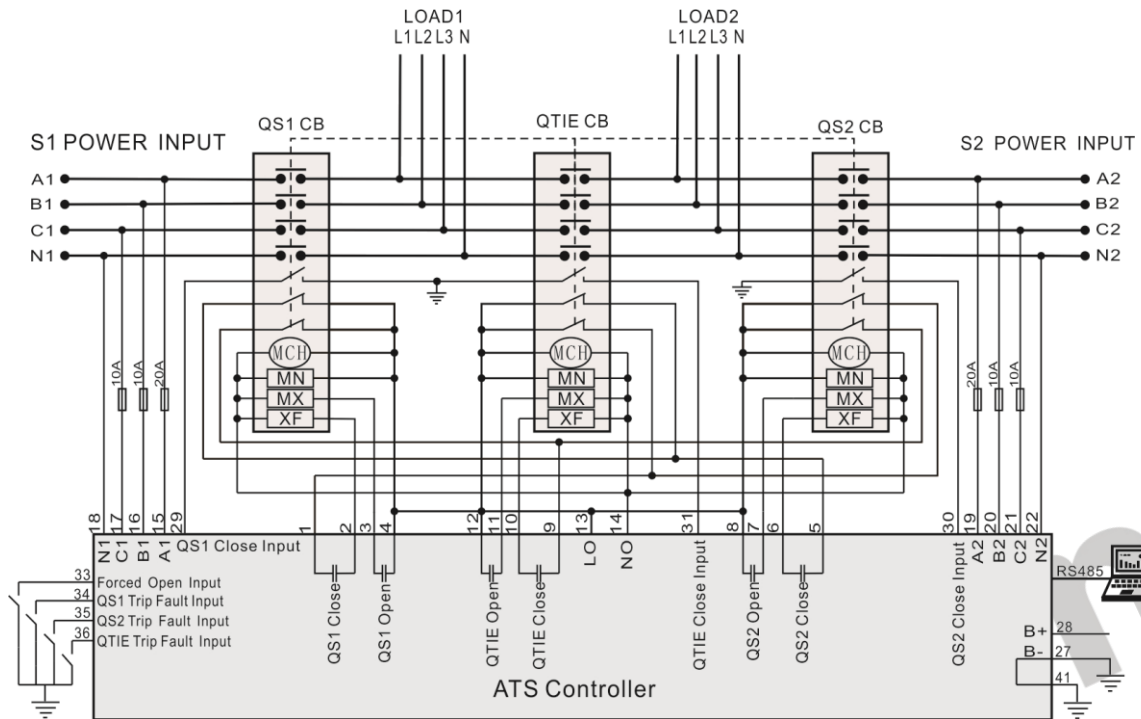

Fig.4 –Breaker Application Diagram 1 (Recommended)

MCH: Stored Energy Motor; MN: Under Voltage Trip; MX: Open Relay; XF: Close Relay;
 In the drawing, MCH, MN and MX/XF are all AC220V.

Table 24 – Corresponding Settings

Partial Parameters Setting	
Aux. Output 1	QS1 Close
Aux. Output 2	QS1 Open
Aux. Output 3	QS2 Close
Aux. Output 4	QS2 Open
Aux. Output 5	QTIE Close
Aux. Output 6	QTIE Open
Aux. Input 1	Forced Open
Aux. Input 2	QS1 Trip Fault
Aux. Input 3	QS2 Trip Fault
Aux. Input 4	QTIE Trip Fault

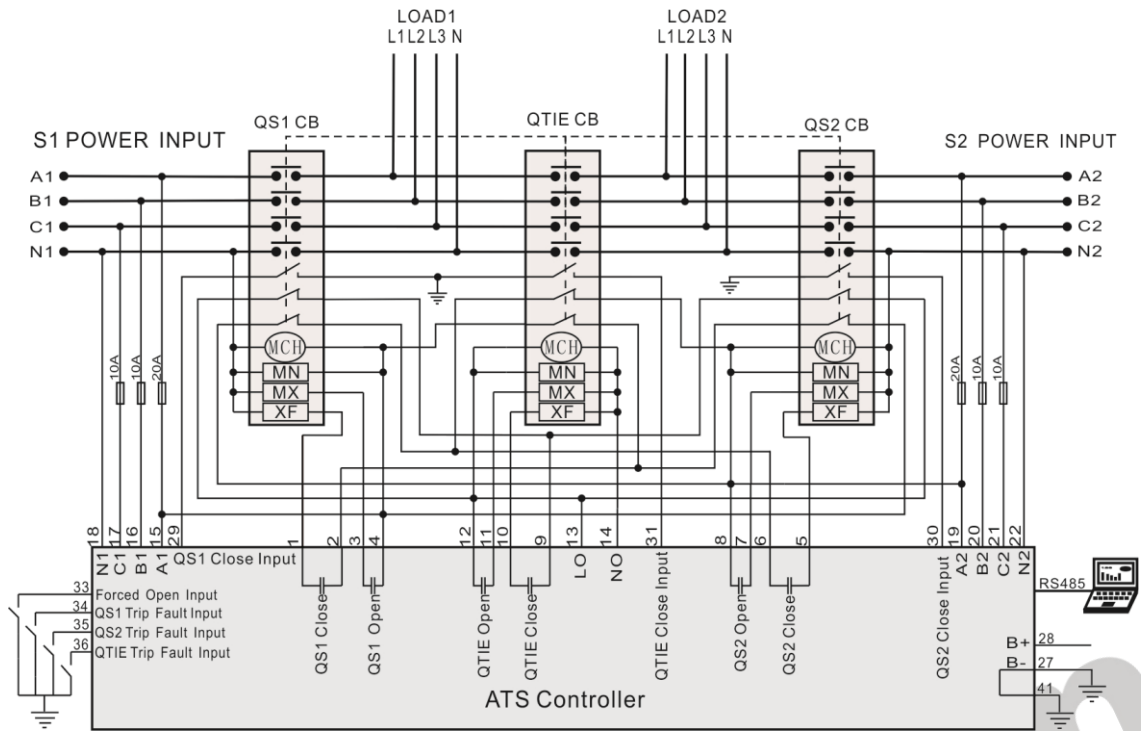

Fig. 5 - Breaker Application Diagram 2

MCH: Stored Energy Motor; MN: Under Voltage Trip; MX: Open Relay; XF: Close Relay;
 In the drawing, MCH, MN and MX/XF are all AC220V.

This application is only suitable for breakers with under voltage trip device.

Table 25 - Corresponding Settings

Partial Parameters Setting	
Aux. Output 1	QS1 Close
Aux. Output 2	QS1 Open
Aux. Output 3	QS2 Close
Aux. Output 4	QS2 Open
Aux. Output 5	QTIE Close
Aux. Output 6	QTIE Open
Aux. Input 1	Forced Open
Aux. Input 2	QS1 Trip Fault
Aux. Input 3	QS2 Trip Fault
Aux. Input 4	QTIE Trip Fault

NOTE: Above diagram is only an example. Users shall do the wiring based on actual circumstances.

15 INSTALLATION

Controller is panel built-in design; it is fixed by clips when installed.

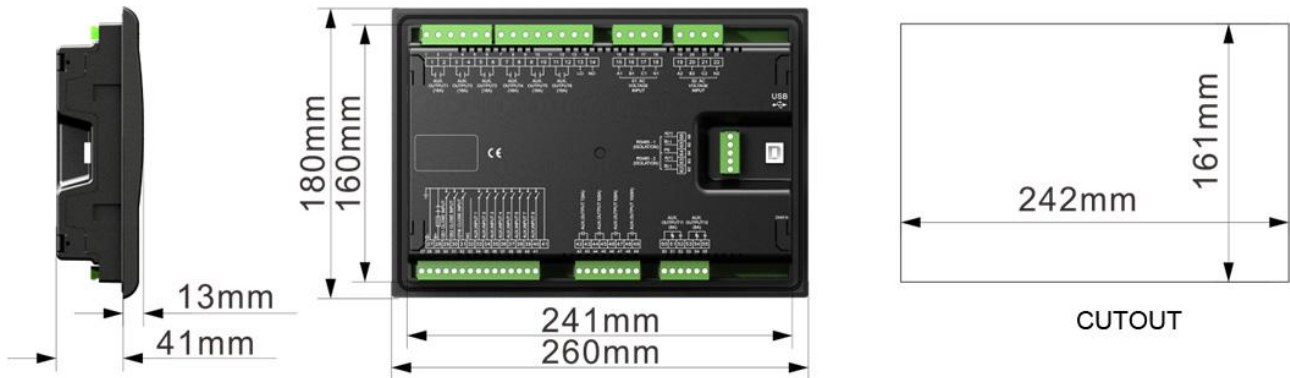

Fig. 6 – Overall & Cutout Dimensions

16 CLIPS INSTALLATION

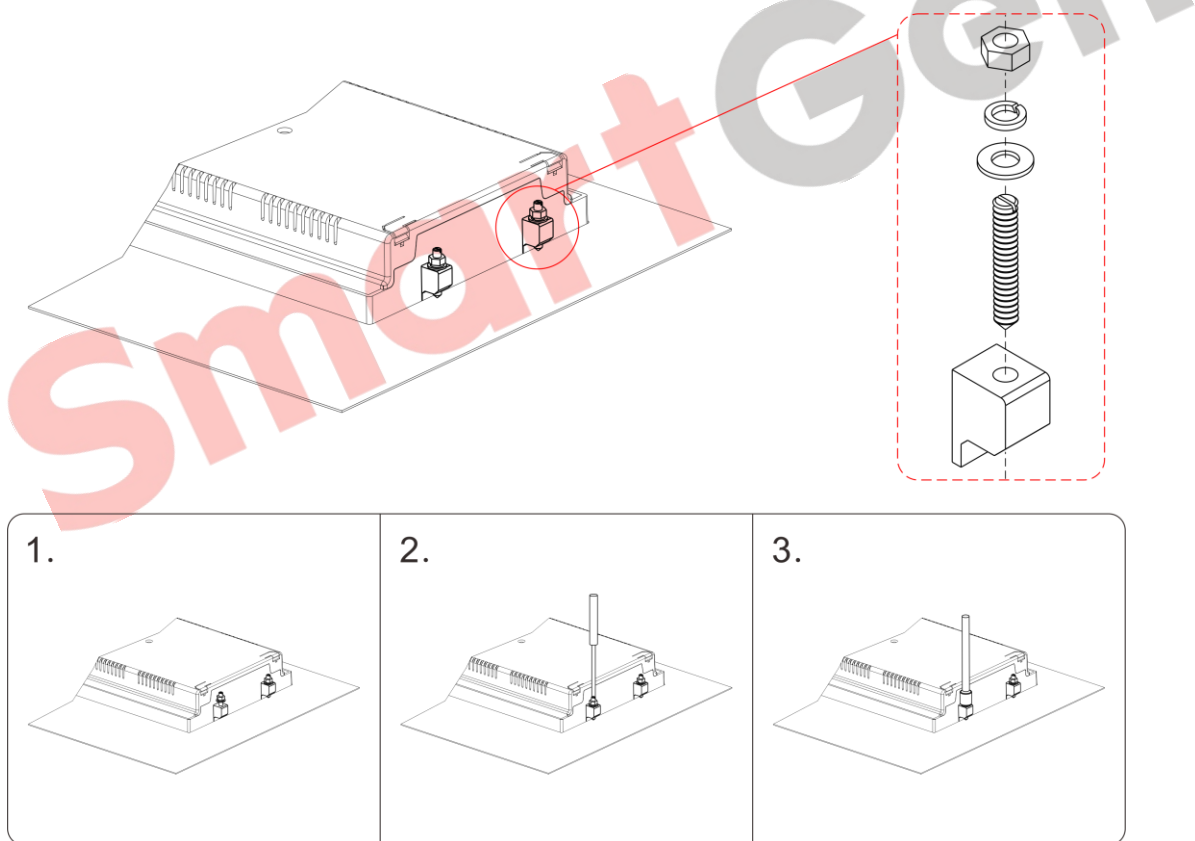

Fig.7 – Clips Installation Drawing

Installation Steps:

1. Install these 4 clips (put into grooves in front panel) in turn.
2. Tighten the screws by using straight screwdriver.
3. Tighten the 4 hex nuts by using M4 sleeve.

Table 26 - Troubleshooting

Symptoms	Possible Solutions
Controller no response with power.	<p>Check DC voltage.</p> <p>Check DC fuse.</p> <p>Check AC Power supply.</p>
RS485 communication is abnormal	<p>Check RS485's connections of A and B is reverse connect or not.</p> <p>Check RS485 transfer model whether damage or not.</p> <p>Check the module address.</p> <p>If above methods can't solve the problem, parallel connection 120Ω resistor between RS485 A terminal and B terminal is recommended.</p>
Auxiliary Output Error	<p>Check auxiliary output connections, pay attention to normally open contact and normally close contact.</p> <p>Check the output settings in parameters settings.</p>
Auxiliary Input Abnormal	<p>Ensure that the auxiliary input is soundly connected to GND when it's active, while hung up when it is inactive.</p> <p>(▲Note: The input port will be possibly destroyed when connected with voltage)</p> <p>Check the input settings in parameters settings.</p>
Genset running while ATS not transfer	<p>Check ATS.</p> <p>Check the connection wirings between the controller and the ATS.</p> <p>Check ATS parameter settings.</p>